

# HITACHI

## SERVICE MANUAL

TY

No. 387 EGF

# HA-6 036

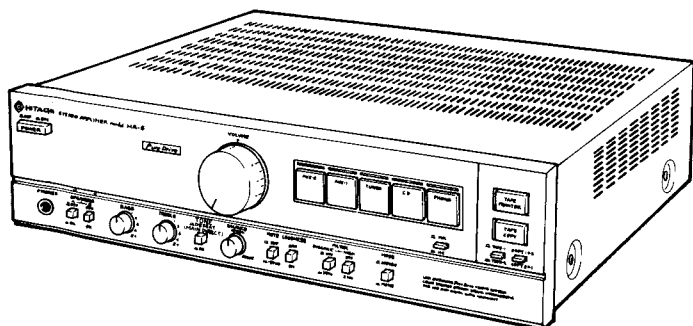

### CONTENTS · INHALT · SOMMAIRE

SPECIFICATIONS · TECHNISCHE DATEN · CARACTÉRISTIQUES TECHNIQUES .....	1,2
FEATURES · MERKMALE · CARACTÉRISTIQUES .....	3
DISASSEMBLY AND REPLACEMENT · ZERLEGUNG UND AUSTAUCH · DEMONTAGE ET REMONTAGE .....	3,4
SERVICE POINTS · WARTUNGSPUNKTE · POINTS DE SERVICE .....	5
ADJUSTMENT · ABGLEICH · REGLAGE .....	6
DESCRIPTION OF THE NEW CIRCUIT · BESCHREIBUNG DES NEUEN SCHALTKREISES · RENSEIGNEMENTS CONCERNANT LE NOUVEAU CIRCUIT .....	6,7
EXPLANATION OF THE NEW PARTS · ERLÄUTERUNG DER NEUEN TEILE · EXPLICATION DES NOUVELLES PIÈCES .....	7,8
CIRCUIT DIAGRAM · SCHALTPLAN · PLAN DE CIRCUIT .....	9
PRINTED WIRING BOARD · PRINTPLATTEN · PLAN DE BASE .....	10,11
CHECKING THE OPERATION OF THE PROTECTION CIRCUIT · KONTROLLE DER FUNKTION DER SCHUTZSCHALTUNG · CONTRÔLE DE FONCTIONNEMENT DU CIRCUIT DE PROTECTION .....	12~15
BLOCK DIAGRAM · BLOCK SCHEMA · SCHEMA .....	15
REPLACEMENT PARTS LIST · ERSATZTEILLISTE · TABLEAU DES PIÈCES .....	16~20
FRONT AND REAR PANEL · VORDERE UND HINTERE BEDIENUNGSTAFEL · PANNEAUX AVANT ET ARRIÈRE .....	21,22

### SAFETY PRECAUTION

The following precautions should be observed when servicing.

1. Since many parts in the unit have special safety related characteristics, always use genuine Hitachi's replacement parts. Especially critical parts in the power circuit block should not be replaced with other makers. Critical parts are marked with  $\Delta$  in the circuit diagram and printed wiring board.
2. Before returning a repaired unit to the customer, the service technician must thoroughly test the unit to ascertain that it is completely safe to operate without danger of electrical shock.

### SPECIFICATIONS

<b>Power output (Both channels driven)</b>	100 Watts* per channel, min. RMS, at 8 ohms from 20 Hz to 20 kHz, with no more than 0.005% total harmonic distortion. 105 W/ch + 105 W/ch (8 ohms, 1 kHz, T.H.D. 0.005% SINUS) 100 W/ch + 100 W/ch (8 ohms, 20 Hz - 20 kHz, T.H.D. 0.005%)	<b>Output level</b> <b>TAPE REC OUT 1,2</b> 150 mV/560 ohms
<b>Harmonic distortion (8 ohms) (at 1/2 rated output)</b>	0.005%	<b>Phono overload level (at 1 kHz T.H.D. 0.01%)</b> MM: 230 mV, MC: 20 mV
<b>Intermodulation distortion (at 1/2 rated output)</b>	0.005%	<b>Signal-to-noise-ratio (IHF, A network)</b>
<b>Power bandwidth</b>	5 Hz - 40 kHz, (T.H.D. 0.1%, 1/2 Rated)	<b>PHONO</b> 90 dB (MM), 70 dB (MC)
<b>Frequency characteristics</b>		<b>CD, TUNER, AUX-1,2</b> 105 dB
<b>PHONO</b>	20 Hz - 20 kHz, RIAA $\pm 0.2$ dB (MM)	<b>TAPE 1,2</b> 80 (1 kHz, 8 ohms)
<b>CD, TUNER, AUX-1,2, TAPE 1,2</b>	5 Hz - 200 kHz (-3 dB)	<b>Bass control</b> $\pm 8$ dB (100 Hz)
<b>Input sensitivity/Impedance</b>		<b>Treble control</b> $\pm 8$ dB (10 kHz)
<b>PHONO</b>	MM 2.5 mV/47 k-ohms MC 0.25 mV/100 ohms	<b>Loudness control</b> +6 dB (100 Hz) +3 dB (10 kHz)
<b>CD, TUNER, AUX 1,2, TAPE PLAY 1,2</b>	150 mV/47 k-ohms 150 mV/47 k-ohms	<b>Subsonic filter/High filter</b> 30 Hz (-6 dB/oct) 8 kHz (-6 dB/oct)
		<b>Power supply</b> AC 120 V 60 Hz, ~ 220 V 50/60 Hz, ~ 240 V 50/60 Hz or ~ 120 V/220 V/240 V 50/60 Hz
		<b>Power consumption</b> 500 W (at rated output) 350 W/450 VA (at 1/3 rated output) 200 W (at 1/10 rated output) (for U.S.A.)
		<b>Dimensions</b> 435(W) $\times$ 115(H) $\times$ 386(D) mm
		<b>Weight</b> 10.5 kg

\* Measured pursuant to the Federal Trade Commission's Trade Regulation Rule on Power Output Claims for Amplifiers.

SPECIFICATIONS AND PARTS ARE SUBJECT TO CHANGE FOR IMPROVEMENT.

## STEREO AMPLIFIER

September 1983

TOYOKAWA WORKS

## SICHERHEITSMASSNAHMEN

Bei Wartungsarbeiten sind die folgenden Sicherheitsmaßnahmen zu beachten :

1. Da verschiedene Teile dieses Gerätes Sicherheitsfunktionen aufweisen, nur Original-Hitachi-Ersatzteile verwenden. Kritische Teile im Netzteil sollten nicht durch ähnliche Teile anderer Hersteller ersetzt werden. Alle kritischen Teile sind im Schaltplan und im Diagramm der Schaltplattinen mit dem Symbol  $\Delta$  gekennzeichnet.
2. Vor der Auslieferung eines reparierten Gerätes an den Kunden muß der Wartungstechniker das Gerät einer gründlichen Prüfung unterziehen, um sicherzustellen, daß sicherer Betrieb ohne die Gefahr von elektrischen Schlägen gewährleistet ist.

## TECHNISCHE DATEN

<b>Ausgangsleistung (2-Kanalbetrieb)</b>	105 Watt/Kanal + 105 Watt/Kanal (8 Ohm 1 kHz, 0.005% Klirr, Nennleistung)	<b>Phonoüberlastungspegel (bei 1 kHz, 0,01% Klirr)</b>	MM 230 mV, MC 20 mV
	100 Watt/Kanal + 100 Watt/Kanal (8 Ohm, 20 Hz - 20 kHz, 0.005% Klirr)	<b>Geräuschspannungsabstand (IHF, A-Nets)</b>	
		<b>PHONO</b>	90 dB (MM), 70 dB (MC)
<b>Klirrfaktor (8 Ohms) (be halber Nennleistung)</b>	0,005%	<b>CD, TUNER, AUX-1,2</b>	
<b>Intermodulationsverzerrung (bei halber Nennleistung)</b>	0,005%	<b>TPAE 1,2</b>	105 dB
<b>Leistungsbandbreite</b>	5 Hz - 40 kHz, (0,1% Klirr bei halber Nennleistung)	<b>Dämpfungsfaktor</b>	80 (1 kHz, 8 Ohms)
<b>Frequenzcharakteristik PHONO</b>	20 Hz - 20 kHz, RIAA-Kennlinie $\pm 0,2$ dB (MM)	<b>Tiefeinstellung</b>	$\pm 8$ dB (100 Hz)
<b>CD, TUNER, AUX 1,2</b>		<b>Höheneinstellung</b>	$\pm 8$ dB (10 kHz)
<b>TAPE 1,2</b>	5 Hz - 200 kHz (-3 dB)	<b>Gehörrichtige Lautstärkekorrektur</b>	+6 dB (100 Hz) +3 dB (10 kHz)
<b>Eingangsempfindlichkeit/Impedanz PHONO</b>	MM 2,5 mV/47 KOhms MC 0,25 mV/100 Ohms	<b>Infraschallfilter-Schalter/ Hochfrequenzfilter</b>	30 Hz (-6 dB/oct) 8 kHz (-6 dB/oct)
<b>CD, TUNER, AUX 1,2</b>	150 mV/47 kOhms	<b>Netzspannung</b>	~ 120V 60 Hz, ~ 220V 50/60 Hz, ~ 240V 50/60 Hz oder ~ 120 V/220 V/240 V 50/60 Hz
<b>TAPE PLAY 1,2</b>	150 mV/47 kOhm	<b>Leistungsaufnahme</b>	500 W (bei 1/3 Nennleistung) 350 W/350 VA (bei 1/3 Nennleistung) 200 W (bei 1/10 Nennleistung)(für USA)
<b>Ausgangspegel TAPE REC OUT 1,2</b>	150 mV/560 Ohm	<b>Abmessungen</b>	435(W) x 115(H) x 386(T) mm
		<b>Gewicht</b>	10,5 kg

Änderungen der Konstruktion und technischen Daten bleiben im Sinne der ständigen Verbesserung vorbehalten.

## PRÉCAUTIONS DE SÉCURITÉ

Les précautions suivantes doivent être observées chaque fois qu'une réparation doit être faite.

1. Etant donné que de nombreux composants de l'appareil possèdent des caractéristiques relatives à la sécurité, utiliser uniquement des pièces de rechange d'origine Hitachi pour effectuer un remplacement. Ceci se rapporte notamment aux pièces critiques du bloc d'alimentation qui ne doivent en aucun cas être remplacées par celles d'autres fabricants. Les pièces critiques sont accompagnés du symbole  $\Delta$  dans le schéma de montage et sur le schéma de plaque de câblage.
2. Avant de retourner l'appareil réparé au client le technicien doit procéder à un essai complet pour s'assurer qu'il ne présente aucun danger de chocs électriques.

## CARACTERISTIQUES TECHNIQUES

<b>Puissance de sortie (deux canaux)</b>	105 W/canal + 105 W/canal (8 ohms, 1 kHz, D.H.T. 0,005% sinus)	<b>Rapport signal/bruit (IHF, réseau A)</b>	
	100 W/canal + 100 W/canal (8 ohms, 20 Hz - 20 kHz D.H.T. 0,005%)	<b>PHONO</b>	90 dB (MM), 70 dB (MC)
<b>Distorsion harmonique (8 ohms) (à 1/2 de sortie nominale)</b>	0,005%	<b>CD, TUNER, AUX 1,2</b>	
<b>Distorsion d'intermodulation (à 1/2 de sortie nominale)</b>	0,005%	<b>TAPE 1,2</b>	105 dB
<b>Gamme de fréquence</b>	5 Hz - 40 kHz (D.H.T. 0,1% 1/2 de sortie nominale)	<b>Facteur d'amortissement</b>	80 (1 kHz, 8 ohms)
<b>Caractéristiques de fréquence PHONO</b>	20 Hz à 20 kHz, RIAA $\pm 0,2$ dB (MM)	<b>Réglage des graves</b>	$\pm 8$ dB (100 Hz)
<b>CD, TUNER, AUX-1,2</b>		<b>Réglage des aigues</b>	$\pm 8$ dB (10 kHz)
<b>TAPE 1,2</b>	5 Hz à 200 kHz (-3 dB)	<b>Correction physiologique</b>	+6 dB (100 Hz) +3 dB (10 kHz)
<b>Sensibilité d'entrée/Impédance PHONO</b>	MM 2,5 mV/47 kohms MC 0,25 mV/100 ohms	<b>Filtre infra-acoustique/ Filtre de haute fréquence</b>	30 Hz (-6 dB/oct) 8 kHz (-6 dB/oct)
<b>CD, TUNER, AUX 1,2</b>	150 mV/47 kohms	<b>Alimentation</b>	CA ~ 120 V 60 Hz, ~ 220 V 50 Hz, ~ 240 V 50/60 Hz ou ~ 120 V/220 V/240 V 50/60 Hz
<b>TAPE PLAY 1,2</b>	150 mV/47 kohms	<b>Consommation</b>	500 W (à la puissance nominale) 350 W/450 VA (à 1/3 de la puissance nominale) 200 W (à 1/10 de la puissance nominale)(pour USA)
<b>Niveau de sortie TPAE REC OUT 1,2</b>	150 mV/560 ohms	<b>Dimensions</b>	435(L) x 115(H) x 386(P) mm
<b>Niveau de surcharge de table de lecture (à 1 kHz, D.H.T. 0,01%)</b>	MM: 230 mV, MC 20 mV	<b>Poids</b>	10,5 kg

Les caractéristiques techniques et la présentation peuvent être modifiées sans préavis pur des raisons d'amélioration.

**FEATURES**

- |   |  |
|---|--|
| <ol style="list-style-type: none"> <li>1. Such a High Power as 100 W + 100 W</li> <li>2. Multi-function Input Switch</li> <li>3. Incorporation of Pure Drive Circuit</li> <li>4. High Power Supply Circuit</li> </ol> | <ol style="list-style-type: none"> <li>5. Use of High-quality Parts</li> <li>6. Employment of Relays for Speaker Changeover Circuit</li> </ol> |
|---|--|

**MERKMALE**

- |  |   |
|--|---|
| <ol style="list-style-type: none"> <li>1. Hohe Leistung mit 100 W + 100 W</li> <li>2. Reichliche Funktionen</li> <li>3. PURE-DRIVE-Stromkreis</li> </ol> | <ol style="list-style-type: none"> <li>4. Kraftvolle Stromversorgung</li> <li>5. Verwendung von Teilen hoher Qualität</li> <li>6. Relaisverwendung für Lautsprecherumschaltung</li> </ol> |
|--|---|

**CARACTERISTIQUES**

- |  |  |
|--|--|
| <ol style="list-style-type: none"> <li>1. Grande puissance de 100 W + 100 W</li> <li>2. Fonctions abondantes</li> <li>3. Réseau de commande pure (PURE DRIVE)</li> </ol> | <ol style="list-style-type: none"> <li>4. Alimentation puissante</li> <li>5. Utilisation de composants de haute qualité</li> <li>6. Les enceintes commutées par un relais</li> </ol> |
|--|--|

**DISASSEMBLY AND REPLACEMENT. ZERLEGUNG UND AUSTAUCH. DEMONTAGE ET REMONTAGE**

- Removing the cover, escutcheon ass'y
- Ausbau der Abdeckung und der Schildanbringung
- Déposer le couvercle, le cache-entrée

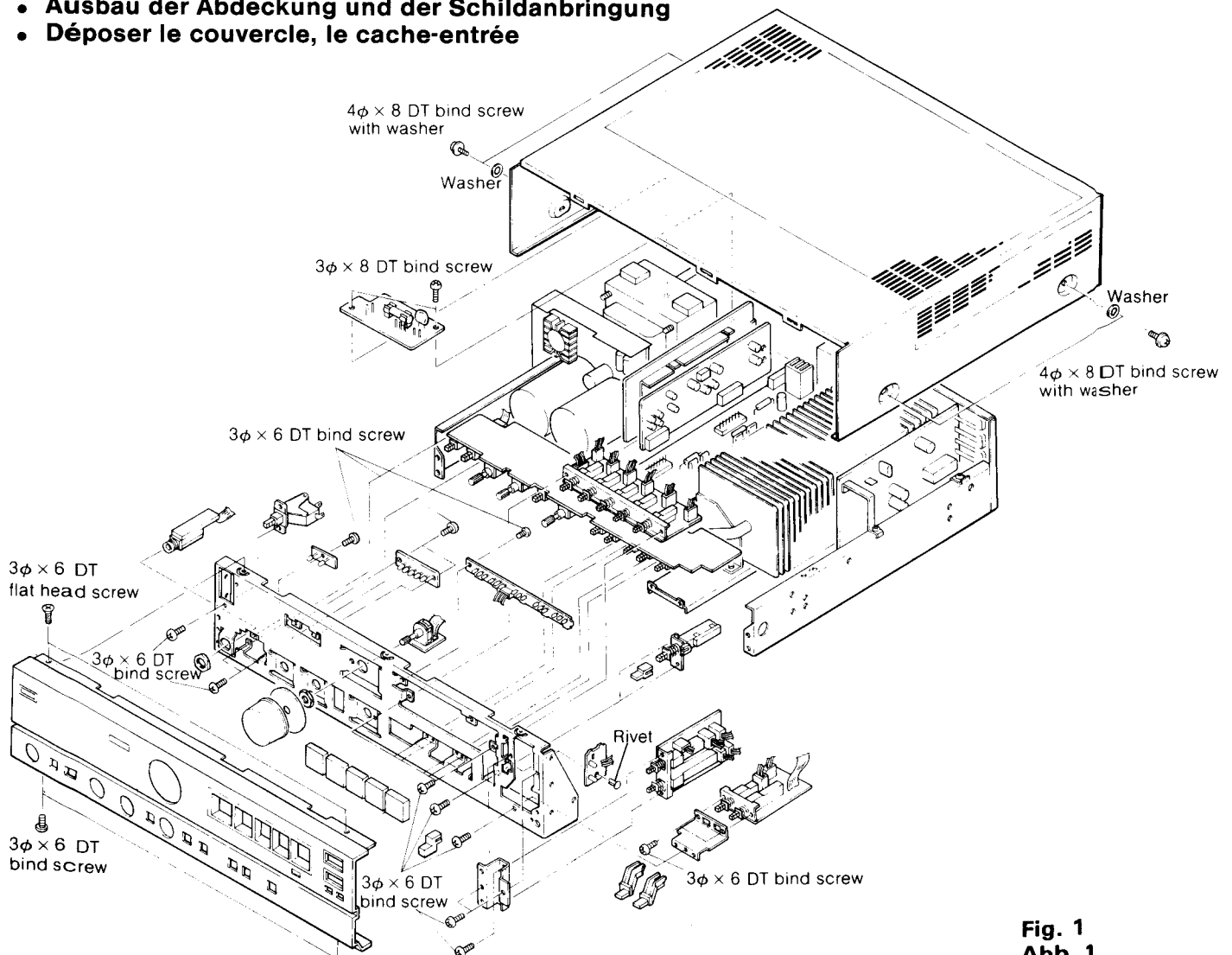

**Fig. 1  
Abb. 1**

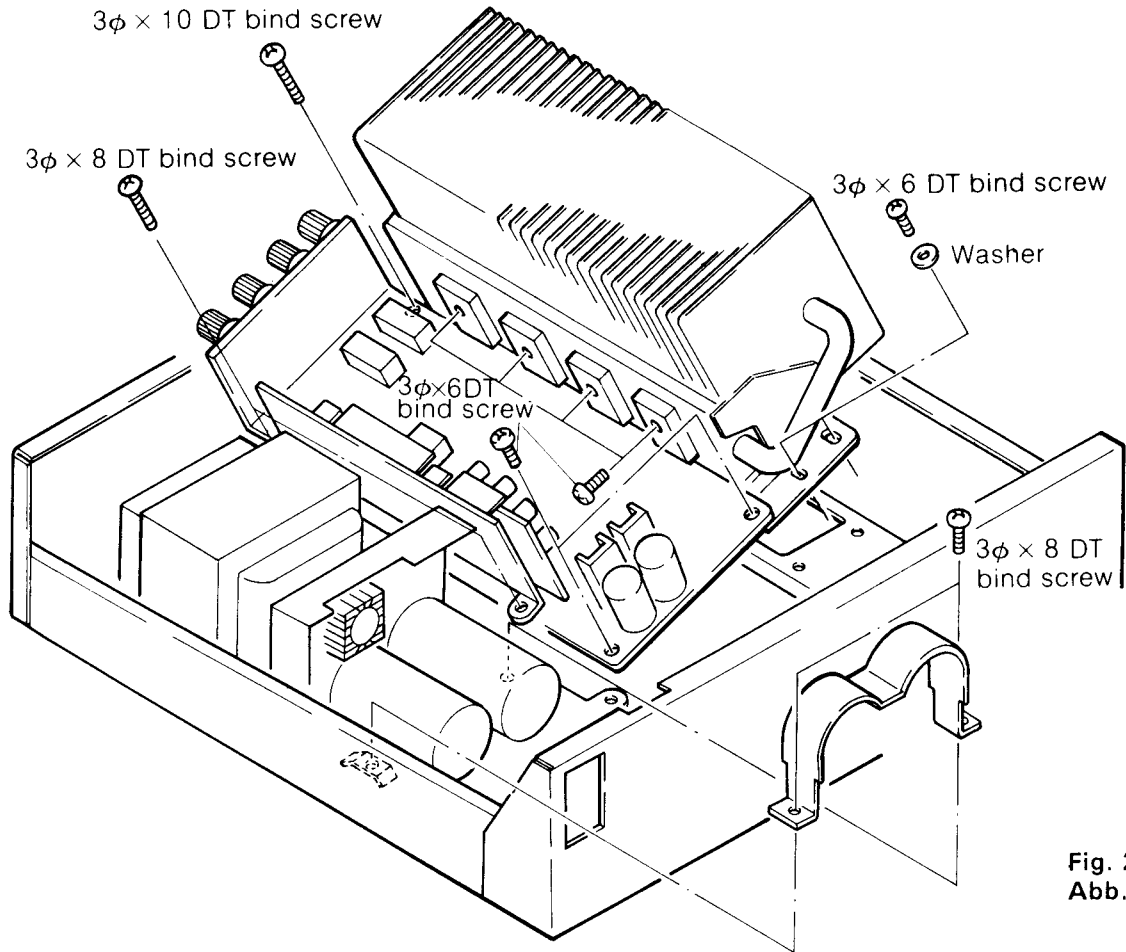

Fig. 2  
Abb. 2

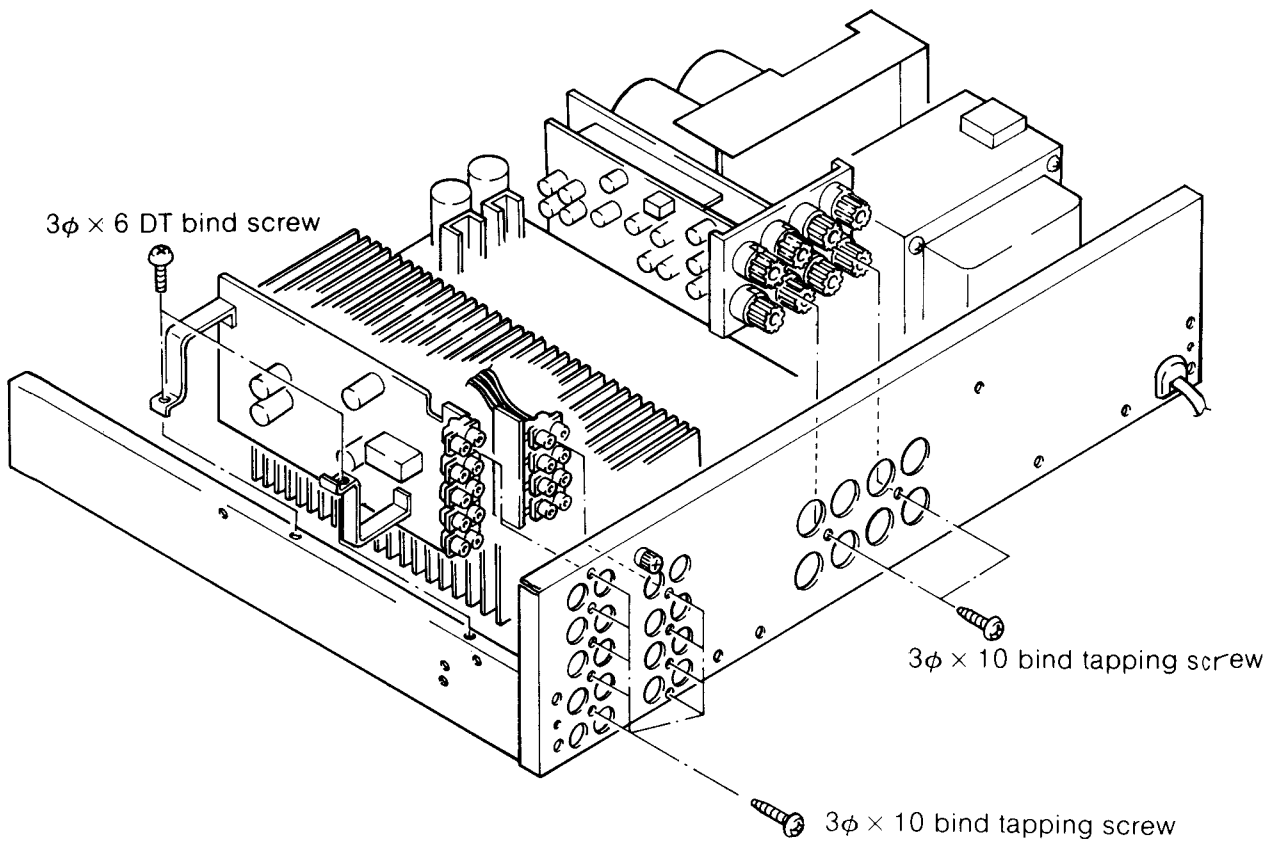

Fig. 3  
Abb. 3

## SERVICE POINTS . WARTUNGSPUNKTE . POINTS DE SERVICE

- **As this unit uses a large capacity power supply, be careful of the following points when checking and repairing.**

- (1) To check and repair the printed wiring boards, be sure to cut off the power and pull out the power cord. Remove the bottom plate and discharge the power capacitors by touching it with a resistor of approx. 10 ohms, 5 watts capacity at the positions C809 and C810.
- (2) Do not touch the terminals of nearby parts with a DC voltmeter when connecting it for adjusting the idle current as malfunction may result. Handle the DC voltmeter carefully. Wind insulating tape around the screwdriver.

(3) This amplifier employs a heat loop and so when conducting a continuity check, the unit should be placed horizontally or stood on its transformer end.

- **Parts installation method**

Great care is taken in installing parts to improve the safety of products. For example, parts are covered with tubes, or they are kept away from the printed wiring board surface. Be sure to maintain the previous conditions after replacing parts for repair.

- **Da dieses Gerät mit einer Stromversorgung hoher Kapazität ausgerüstet ist, müssen bei Prüfungen bzw. Reparaturen die folgenden Punkte beachtet werden.**

- (1) Für das Prüfen bzw. Reparieren der Schaltplatine unbedingt die Stromversorgung abschalten und das Netzkabel von der Wandsteckdose abziehen. Die Bodenplatte abmontieren und die Leistungskondensatoren entladen, indem die Klemmen an den Punkten C809 und C810 mit einem Widerstand von etwa 10 Ohm (5W) berührt werden.
- (2) Darauf achten, daß die Klemmen benachbarter Teile nicht mit den Anschlüssen des Gleichspannungsmessers berührt werden, wenn dieser für die Messung des Blindstromes angeschlossen wird, da es ansonsten zu Störungen kommen könnte. Den Gleichspannungsmesser vorsichtig behandeln. Isolationsband gegebenenfalls um den Schraubenzieher wickeln.

(3) Dieser Verstärker verwendet eine Wärmeschleife, so daß das Gerät bei einer Durchgangsprüfung horizontal oder auf das Transformatorende gestellt werden sollte.

- **Finbau der Teile**

Bei der Montage des Gerätes wurde besonderes Augenmerk auf Betriebssicherheit gelegt, so daß alle Teile besonders sorgfältig eingebaut wurden. Zum Beispiel wurden bestimmte Leiter mit Kunststoffschläuchen überzogen oder andere in sicherem Abstand von der Schaltplatine angeordnet. Beim Austauschen bzw. Reparieren von Teilen ist daher darauf zu achten, daß die ursprünglichen Sicherheitsmaßnahmen wiederum eingehalten werden.

- **Etant donné que cet appareil emploie une importante capacité d'énergie, faire attention aux points suivants au moment d'effectuer des contrôles et des réparations.**

- (1) Pour contrôler et vérifier les plaques à circuit imprimé, ne pas oublier de couper l'alimentation et de débrancher le cordon secteur. Déposer la plaque de fond et décharger les condensateurs de puissance en les touchant avec une résistance d'environ 10 ohms, 5 watts de capacité aux points C809 et C810.
- (2) Ne pas toucher les bornes proches des condensateurs avec les sondes d'un voltmètre à courant continu au moment du branchement pour le réglage du courant dé Watté car ceci peut provoquer des détériorations. Manipuler délicatement le voltmètre à courant continu. Isoler la tige du tournevis.

(3) Cet amplificateur est doté d'un dissipateur thermique et c'est pourquoi il doit être placé à l'horizontale ou sur son extrémité transformateur quand on procède à un essai de continuité.

- **Procédé de montage des pièces**

Les pièces sont montées en usine avec le plus grand soin pour assurer une sécurité intégrale à l'appareil. Par exemple, les pièces sont protégées par des tubes au tenues à distance des plaquettes à circuit imprimé. S'assurer que ces précautions sont également respectées au remontage.

**ADJUSTMENT . ABGLEICH . REGLAGE**

• **IDLE CURRENT**

<b>Test conditions</b>		FUNCTION ..... Free	VOLUME..... Minimum	SPEAKERS ..... OFF
Item	Measuring instrument	Point to be measured	Adjust	Value adjusted
Idle current	DC voltmeter	Fig. 4	R729L, R	6.6 ±2.2 mV

• **BLINDSTROM**

<b>Versuchsbedingung</b>		FUNKTION ..... Frei	VOLUME ..... Minimum	SPEAKERS ..... OFF
Benennung	Meßinstrument	Zu messender Punkt	Einstellen	Wert eingestellt
Blindstrom	Gleichspannungsmesser	Abb. 4	R729L, R	6.6 ±2.2 mV

• **COURANT DEWATTE**

<b>Conditions pour les essais</b>		FUNCTION ..... Libre	VOLUME ..... Minimal	SPEAKERS ..... OFF
Désignation	Appareil de mesure	Point de mesure	Réglage	Valeur ajustée
Courant déwatté	Voltmètre à C.C.	Fig. 4	R729L, R	6.6 ±2.2 mV

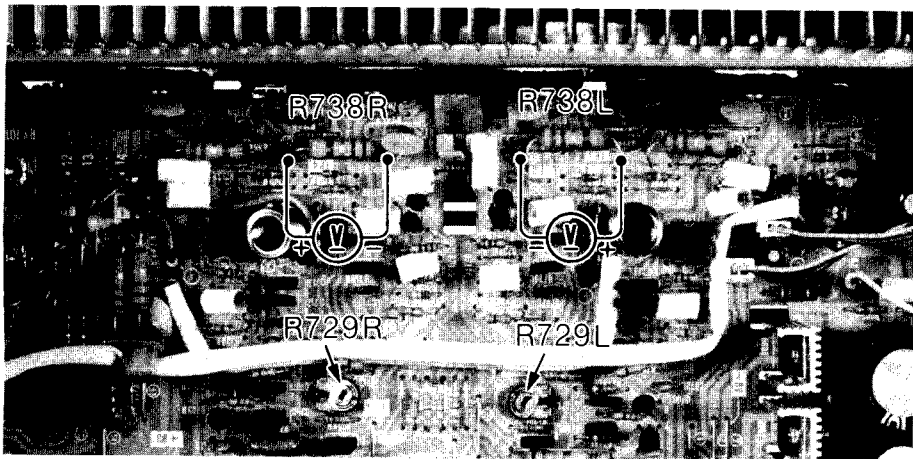

Fig. 4  
Abb. 4

**DESCRIPTION OF THE NEW CIRCUIT . BESCHREIBUNG DES NEUEN SCHALTKREISES . RENSEIGNEMENTS CONCERNANT LE NOUVEAU CIRCUIT**

• **Pure Drive Circuit**

1. This unit employs a pure drive circuit for the volume circuit to prevent the performance and sound quality from being deteriorated on normal operating condition.
2. The input signal from the FUNCTION part is connected to the variable resistor with low resistance in the buffer amplifier. Since this variable resistor has low resistance, the performance of the unit is improved so that the frequency characteristic distortion the normal operation circuit or crosstalk noise, which is liable to be generated due to low resistance when the volume is attenuated, may be suppressed.

• **PURE-DRIVE-Stromkreis**

1. Um Verschlechterung der Leistung und der Klangqualität in normalem Verwendungszustand zu verhüten, verwendet dieses Gerät einen PURE-DRIVE-Stromkreis.

2. Das Eingangssignal von FUNCTION ist an den Niederwiderstandslautstärkereglern des Pufferverstärkers angeschlossen. Da der Widerstandswert des Lautstärkereglers niedrig ist, wird die Leistung in Bezug auf Frequenzgang, Übersprechen usw. bei Dämpfung des Lautstärkereglers (Nennverwendungsstromkreis) verbessert.

• **Circuit de commande pure (PURE DRIVE)**

1. En vue de prévenir une dégradation des performances et de la tonalité à l'état d'utilisation fixe, le circuit de volume comporte un circuit de commande pure (PURE DRIVE).
2. Le signal incident de la FUNCTION est acheminé à un rhéostat de valeur ohmique réduite de l'ampli tampon. La basse résistance améliore les caractéristiques de fréquence, de distortion, de diaphonie, etc. lorsque le niveau sonore est baissé (circuit d'utilisation fixe).

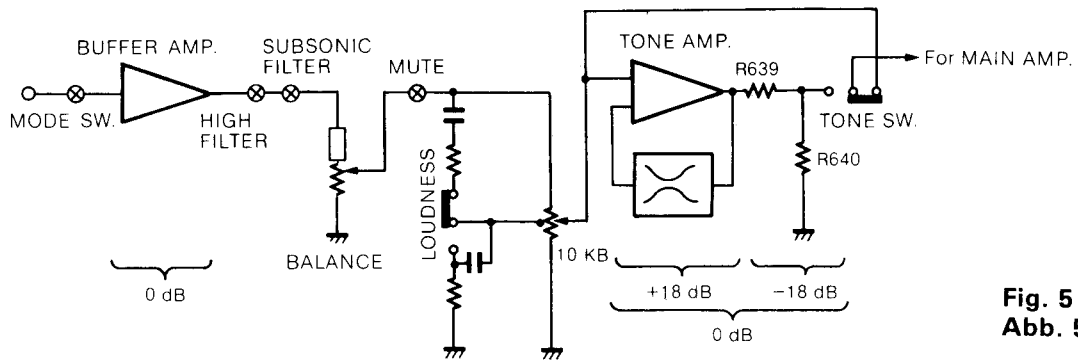

Fig. 5  
Abb. 5

**EXPLANATION OF THE NEW PARTS. ERLÄUTERUNG DER NEVEN TEILE. EXPLICATION DES NOUVELLES PIECES**

**2SC3280**

- Silicon NPN Triple Diffused Transistor
- Silizium-NPN-Dreifachdiffusionstransistor
- Transistor au silicium NPN à triple diffusion

**1. External Form · Form · Dimensions**

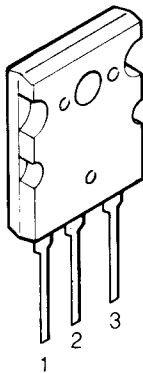

- |         |                          |            |
|---------|--------------------------|------------|
| 1. Base | 2. Collector (heat sink) | 3. Emitter |
| Basis   | Kollektor (Kühlblech)    | Emittter   |
| Base    | Collecteur (dissipateur) | Emetteur   |

**2. Maximum Rating · Maximale Leistung · Caractéristiques maximales (Ta = 25°C)**

Item Punkt Rubrique	Symbol Symbol Symbole	Rating Nennleistung Spécification	Unit Einheit Unité
Collector to base voltage Spannung zwischen Kollektor und Basis Tension collecteur-base	V <sub>CBO</sub>	160	V
Collector to emitter voltage Spannung zwischen Kollektor und Emittter Tension collecteur-émetteur	V <sub>CEO</sub>	160	V
Emitter to base voltage Spannung zwischen Emittter und Basis Tension émetteur-base	V <sub>CEO</sub>	5	V
Collector current Kollektorstrom Courant de collecteur	I <sub>c</sub>	12	A
Base current Basisstrom Courant de base	I <sub>B</sub>	1.2	A
Collector loss (T <sub>c</sub> = 25°C) Kollektorverlust (T <sub>c</sub> = 25°C) Perte de collecteur (T <sub>c</sub> = 25°C)	P <sub>c</sub>	120	W
Junction temperature Verbindungstemperatur Température de jonction	T <sub>j</sub>	150	°C
Storage temperature Haltetemperatur Température de stockage	T <sub>stg</sub>	-55 ~ 150	°C

# HITACHI HA-6

## 2SK146

- For Low-Frequency, Low-Noise Amplifier (for differential amplifier)
- Für Niederfrequenzverstärkung mit geringem Rauschen (für Differentialverstärkerstromkreis)
- Pour amplification à bruit réduit de basse fréquence (pour circuit amplificateur différentiel)

### 1. External Form · Form · Dimensions

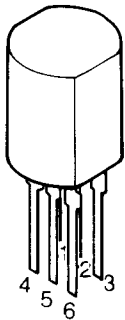

- |                                     |                                     |
|-------------------------------------|-------------------------------------|
| 1. DRAIN 1<br>Drain 1<br>Drain 1    | 4. DRAIN 2<br>Drain 2<br>Drain 2    |
| 2. GATE 1<br>Tor 1<br>Porte 1       | 5. GATE 2<br>Tor 2<br>Porte 2       |
| 3. SOURCE 1<br>Source 1<br>Source 1 | 6. SOURCE 2<br>Source 2<br>Source 2 |

### 2. Maximum Rating · Maximale Leistung ·

#### Caractéristiques maximales (Ta = 25°C)

Item Punkt Rubrique	Symbol Symbol Symbole	Rating Nennleistung Spécification	Unit Einheit Unité
Gate to drain voltage Spannung zwischen Tor und Drain Tension porte-drain	V <sub>GDS</sub>	- 40	V
Gate current Torstrom Courant de porte	I <sub>G</sub>	10	mA
Allowable loss Zulässiger Verlust Perte admissible	P <sub>D</sub>	600 × 2	mW
Junction temperature Verbindungstemperatur Température de jonction	T <sub>j</sub>	125	°C
Storage temperature Halte­temperatur Température de stockage	T <sub>stg</sub>	- 55 ~ 125	°C

## 2SA1301

- Silicon PNP Triple Diffused Transistor
- Silizium-PNP-Dreifachdiffusionstransistor
- Transistor au silicium PNP à triple diffusion

### 1. External Form · Form · Dimensions

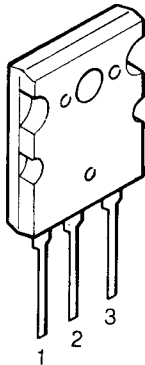

- |                          |   |                                   |
|--------------------------|---|-----------------------------------|
| 1. Base<br>Basis<br>Base | 2. Collector (heat sink)<br>Kollektor (Kühlblech)<br>Collecteur (dissipateur) | 3. Emitter<br>Emitter<br>Emetteur |
|--------------------------|---|-----------------------------------|

### 2. Maximum Rating · Maximale Leistung · Caractéristiques maximales (Ta = 25°C)

Item Punkt Rubrique	Symbol Symbol Symbole	Rating Nennleistung Spécification	Unit Einheit Unité
Collector to base voltage Spannung zwischen Kollektor und Basis Tension collecteur-base	V <sub>CB0</sub>	- 160	V
Collector to emitter voltage Spannung zwischen Kollektor und Emitter Tension collecteur-émetteur	V <sub>CEO</sub>	- 160	V
Emitter to base voltage Spannung zwischen Emitter und Basis Tension émetteur-base	V <sub>EBO</sub>	- 5	V
Collector current Kollektorstrom Courant de collecteur	I <sub>C</sub>	- 12	A
Emitter to base voltage Spannung zwischen Emitter und Basis Tension base-émetteur	I <sub>B</sub>	- 1.2	A
Collector loss (Tc = 25°C) Kollektorverlust (Tc = 25°C) Perte de collecteur (Tc = 25°C)	P <sub>C</sub>	120	W
Junction temperature Verbindungstemperatur Température de jonction	T <sub>j</sub>	150	°C
Storage temperature Halte­temperatur Température de stockage	T <sub>stg</sub>	- 55 ~ 150	°C



CIRCUIT DIAGRAM · SCHALTPLAN · PLAN DE CIRCUIT

CAUTION  
Use the electrolytic capacitors with explosion-proof valve when the diameter of them is more than 10mmφ.

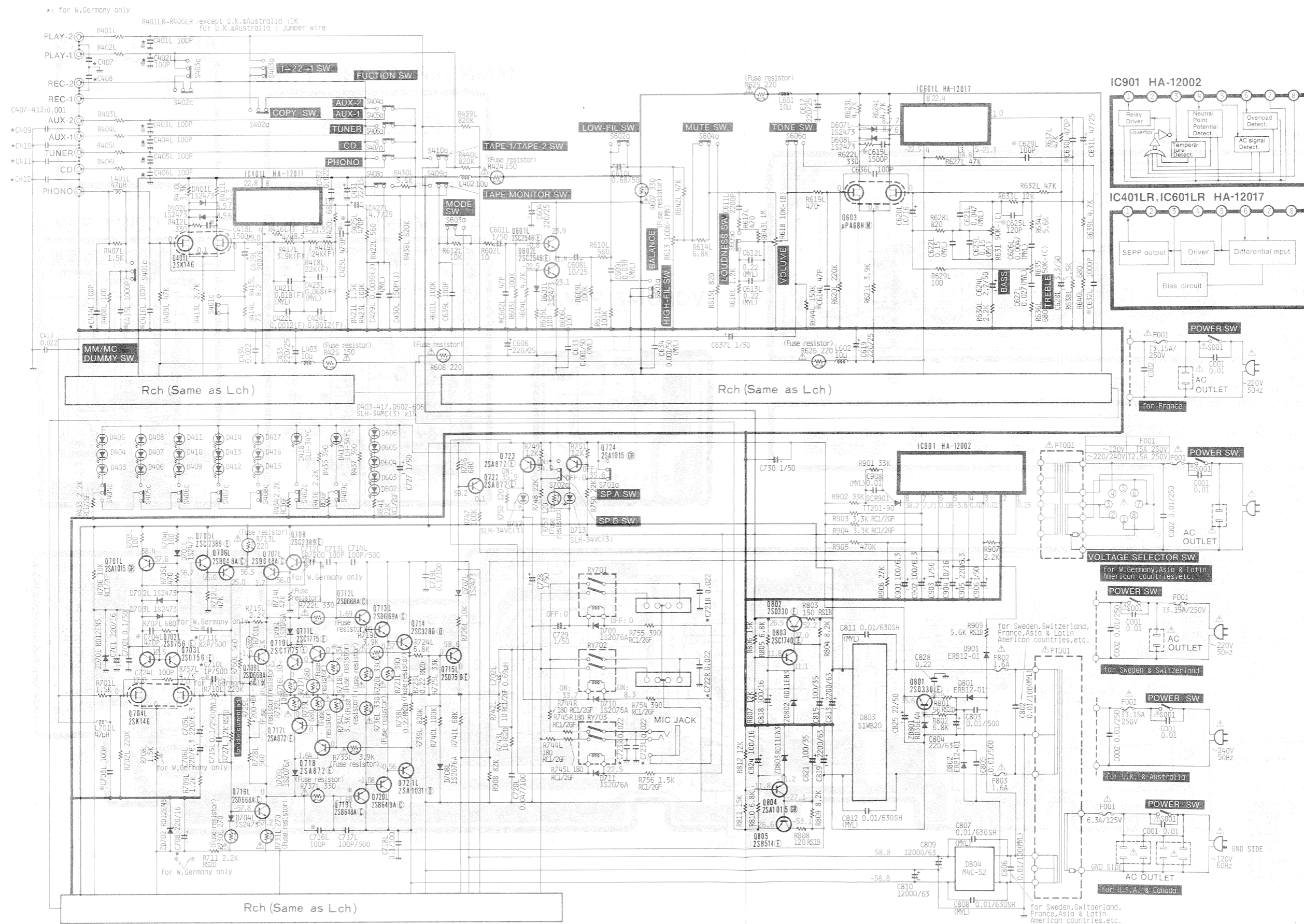

HA-1207 HA-12017	2SK146
HA-12002	1S2473 1S2076A RD12EN3 RD36EB4 RD11EN3
IC401LR, IC601LR HA-12017	2SA1015 (G) 2SC2389 (E) 2SC1775 (E) 2SA872 (E) 2SC1740LN (E) 2SC2546 (E)
POWER SW	ERB12-01R
VOLTAGE SELECTOR SW	MN3008 MN5101
POWER SW	S1WB20
VOLTAGE SELECTOR SW	M4C-52-13
POWER SW	2SC3280 (O) 2SA1301 (O)
VOLTAGE SELECTOR SW	SLH-34MC (3) SLH-34VC (3)
POWER SW	2SD756A (E)
VOLTAGE SELECTOR SW	SLH-34YC (4)
POWER SW	2SD330 (E) 2SD330AL (E) 2SA514AL (E)

PRINTED WIRING BOARD · PRINTPLATTEN · PLAN DE BASE

[ :+B, :-B, :Earth, :Other]

- \* : Axial lead cylindrical ceramic capacitor
- \* : Zylindrischer Keramikcondensator mit axialer Zuleitung
- \* : Condensateur céramique cylindrique à conducteur axial

\*:for W.Germany only

FUNCTION P.W.B.

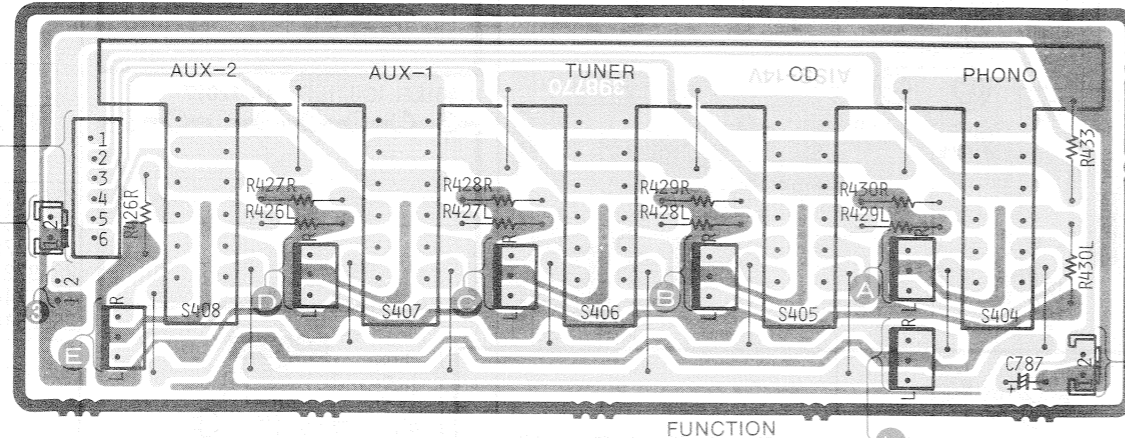

FUNCTION IND. P.W.B.

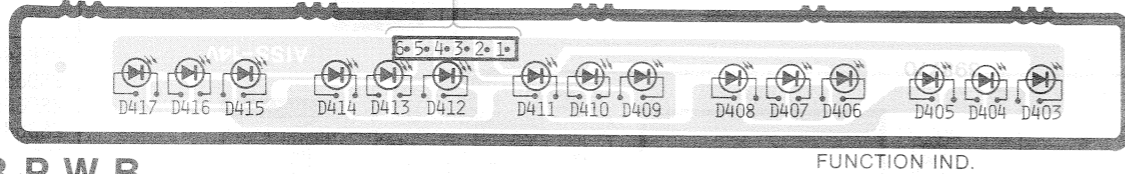

SPEAKER P.W.B.

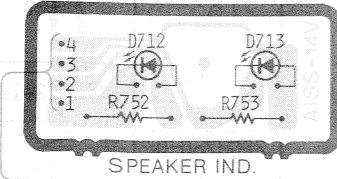

PA P.W.B.

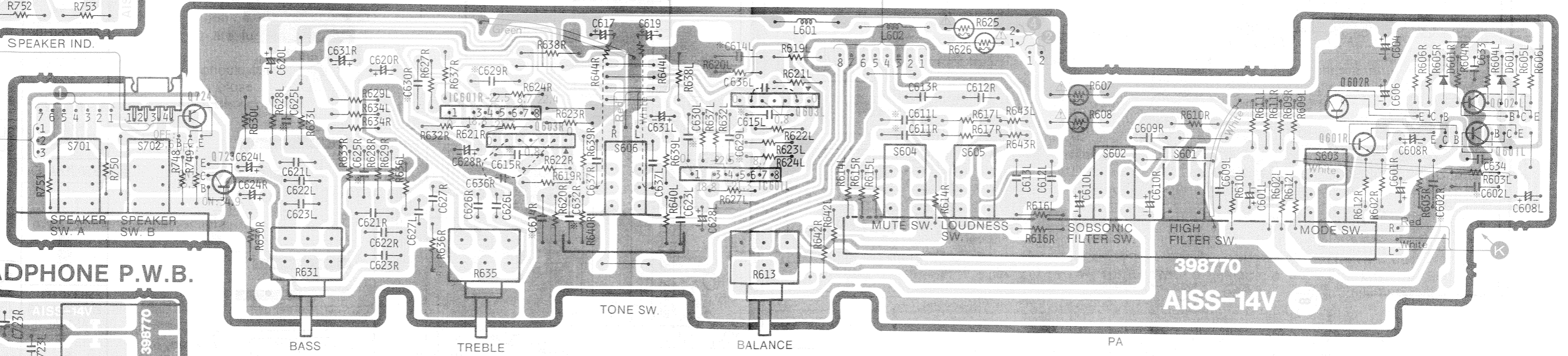

HEADPHONE P.W.B.

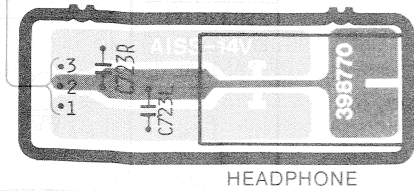

MAIN DIRECT IND. P.W.B.

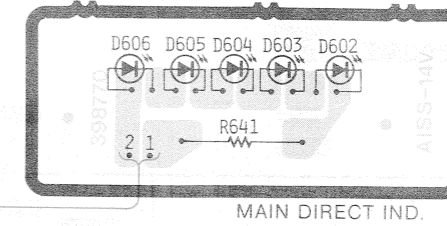

TAPE IND. P.W.B.

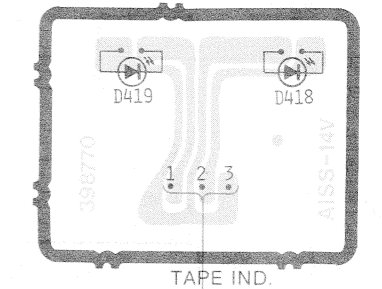

VOLUME P.W.B.

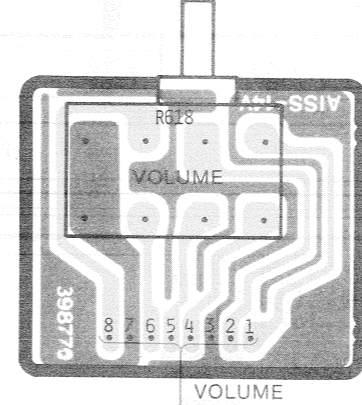

TAPE MONITOR P.W.B.

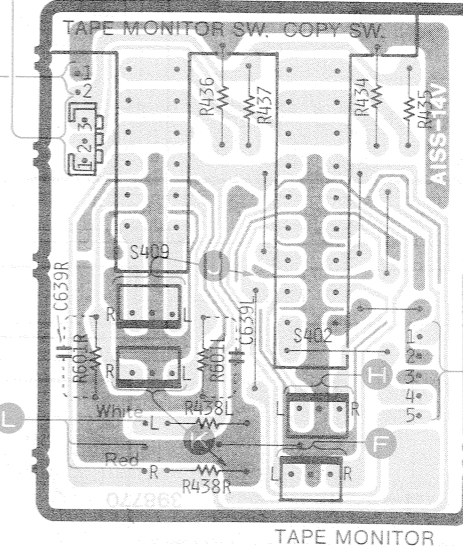

TAPE COPY P.W.B.

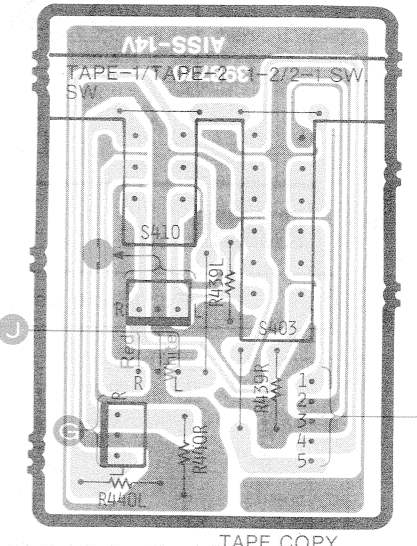

PRINTED WIRING BOARD · PRINTPLATTEN · PLAN DE BASE

[ ■ : +B, ■ : -B, ■ : Earth, ■ : Other ]

- \* : Axial lead cylindrical ceramic capacitor
- \* : Zylindrischer Keramikkondensator mit axialer Zuleitung
- \* : Condensateur céramique cylindrique à conducteur axial

IN PUT 1 P.W.B.

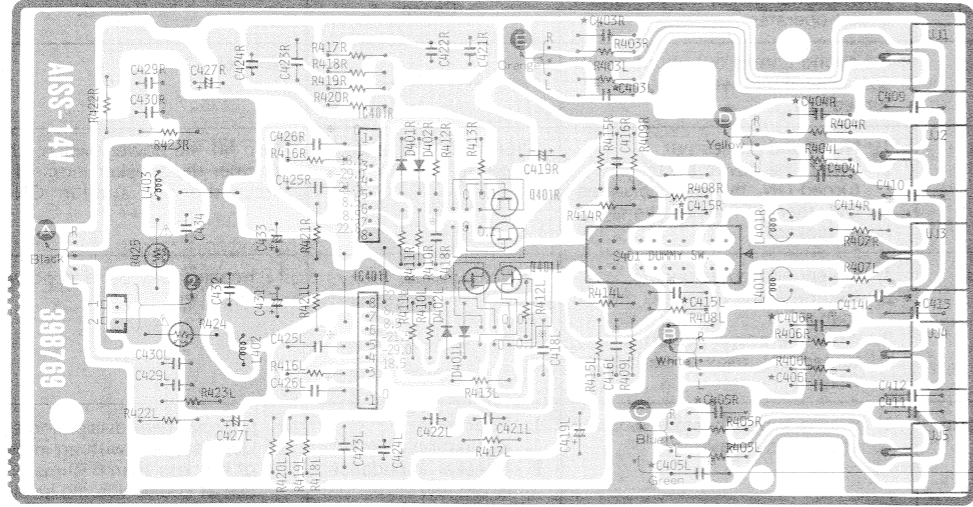

IN PUT 2 P.W.B.

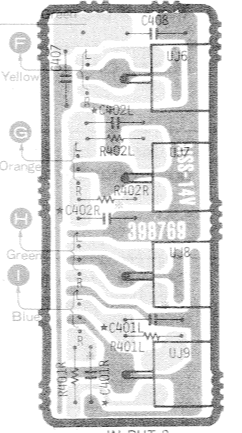

SECONDARY P.W.B.

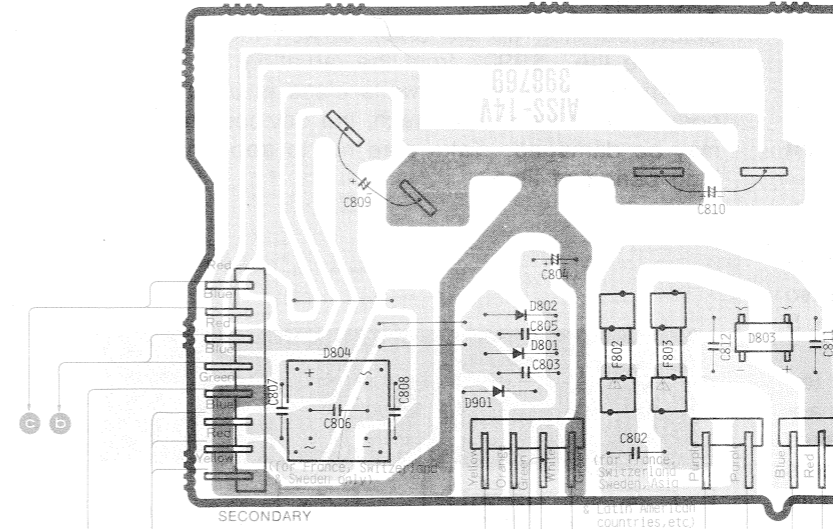

MAIN IN PUT P.W.B.

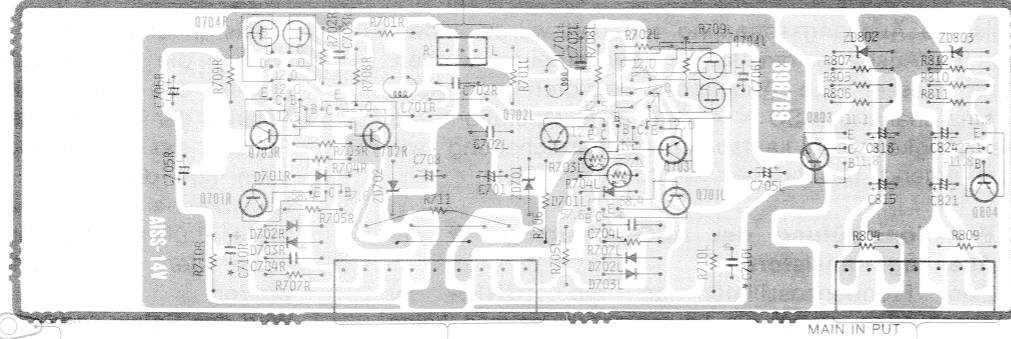

MA P.W.B.

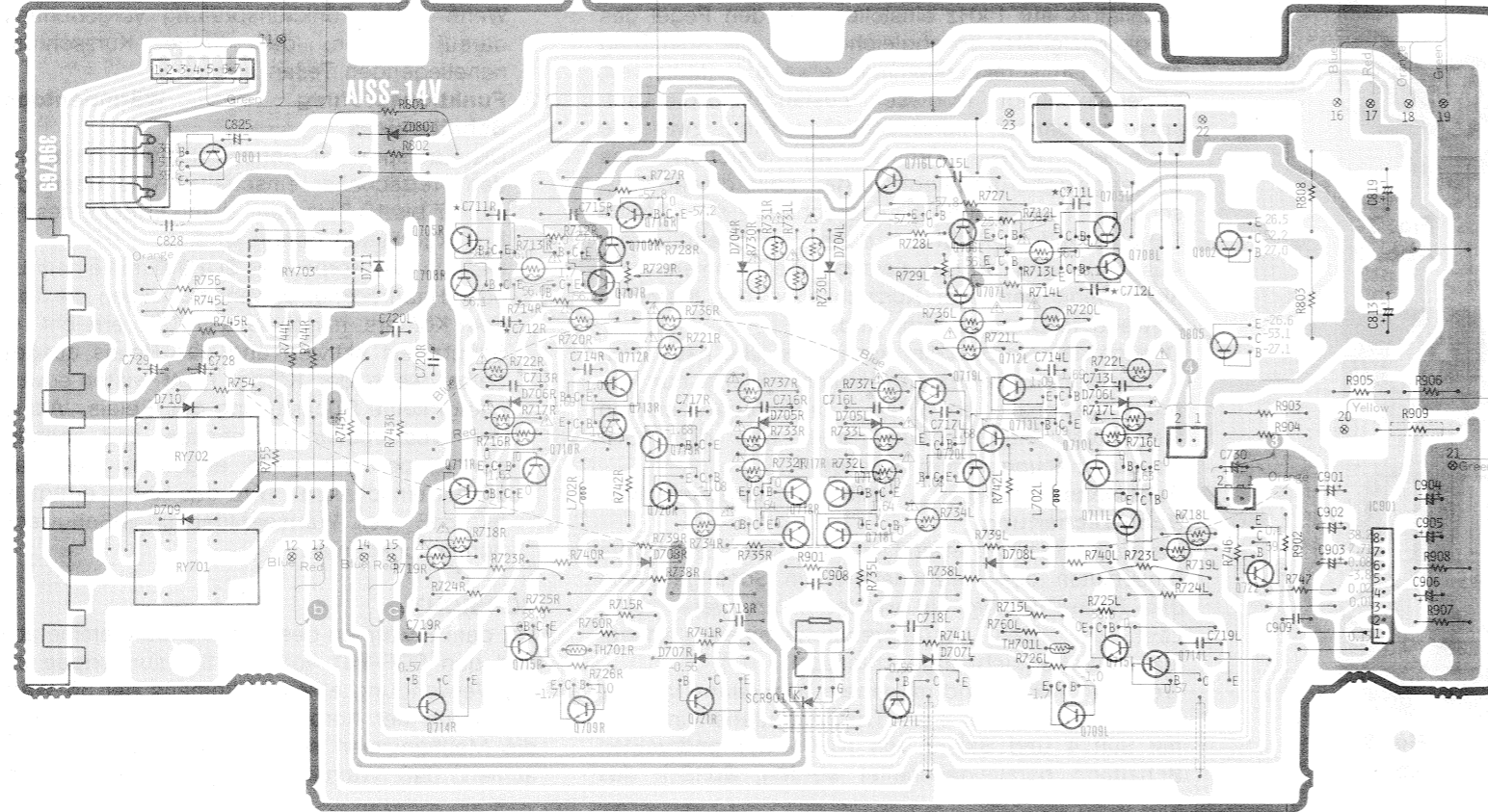

PRIMARY P.W.B.

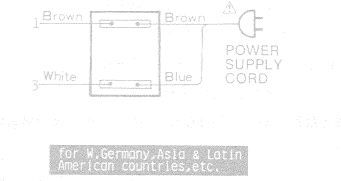
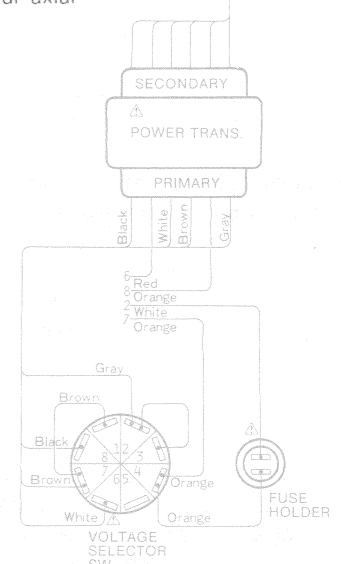
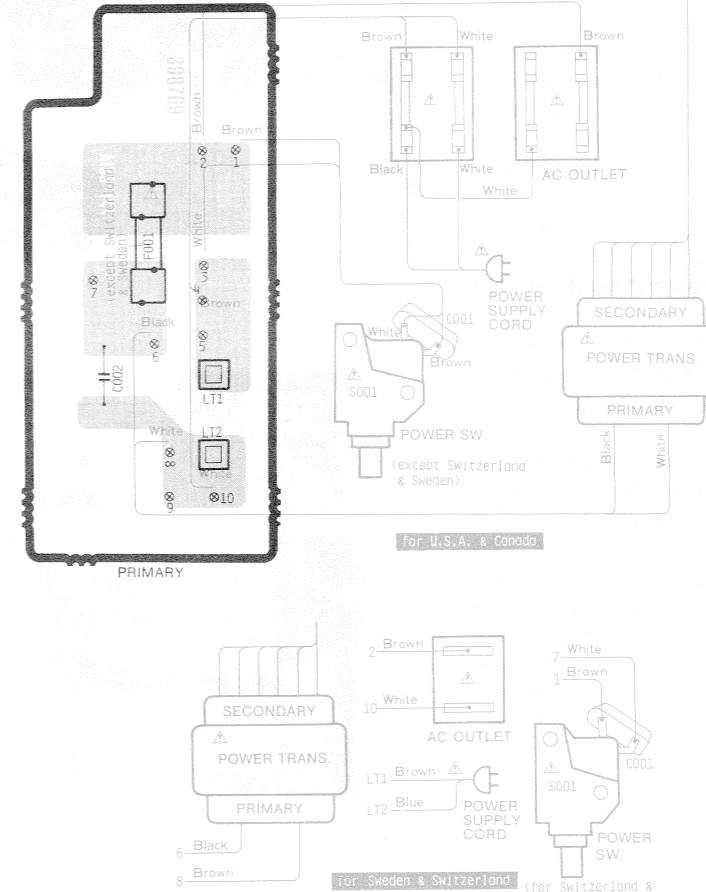

for W. Germany, Asia & Latin American countries, etc.

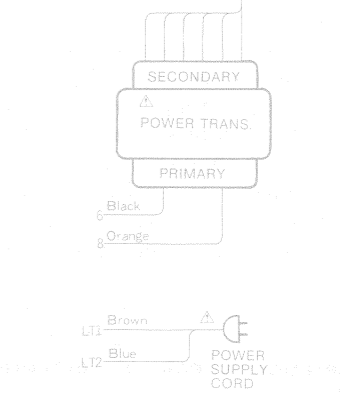

for U.K. & Australia

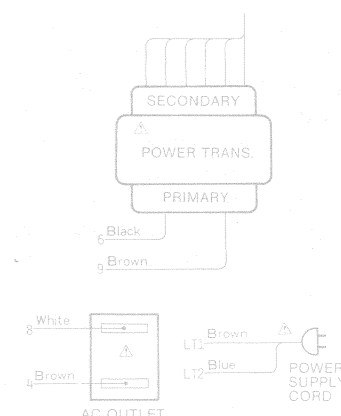

for France

for U.S.A. & Canada

for Sweden & Switzerland

(for Switzerland & Sweden only)

## CHECKING THE OPERATION OF THE PROTECTION CIRCUIT

When the output circuit is repaired by replacing the output transistors, etc., perform an operation check on the ASO (Area of Safe Operation) detection circuit for the output transistors and the speaker protection circuit.

### 1. Operation check of the ASO detection circuit for the output transistors

Connect the audio oscillator to the TUNER IN terminals with the speaker terminals unloaded (speaker: disconnect). Set the frequency of the audio oscillator at 1 kHz and adjust the level of the input signal so that the voltage at the speaker terminals is approx. 5 V rms.

Under these conditions, short-circuit the speaker terminals of the channel to which the input signal is applied using a lead wire, etc. If this short-circuit makes the ASO detection circuit operate, no output appears at the speaker terminals even if the lead wire used for short-circuiting is removed.

Next, turn off the power switch and, after approx. 10 sec., turn the power switch on again. When output comes out of the speaker terminals, this indicates that the ASO detection circuit is operating normally.

### 2. Operation check of the speaker protection circuit

Make sure that the relay operates (a click sound is heard) approx. 7 – 10 seconds after the power switch is turned on with the speaker terminals unloaded (speaker: disconnect).

Next, when a resistor with a resistance of approximately 10 kohms and two 1.5 V dry batteries are connected in series across pins 4 and 2 of main power printed wiring board IC901, the relay turns off within 1 sec. When the dry batteries are taken away, the relay operates again. Next, change the polarities of the dry batteries and carry out the abovementioned operation to check the operation of the relay. If the relay is energized with this operation, it means that the speaker protection circuits are functioning normally.

When conducting this operational check, take care not to create shortcircuits with parts close at hand.

### 3. Operation check of temperature-detection circuit

Leave the speakers disconnected without a load, set the power switch to ON and check that a clicking sound is heard by the relay being energized after a period of 7 to 10 seconds.

Next, warm up the SCR901 body using a soldering iron or a hair dryer. Once the temperature of the body reaches higher than 100°C, the protection circuit is activated and the relay is turned OFF. Even if the body is no longer warmed up, the relay is not reset. Next, set the power switch to OFF and after allowing the body to cool down sufficiently, switch ON the power again. If the relay is energized, it means that the temperature-detection protection circuit is operating normally.

### CAUTION

Before warming up the body, detach the clamp and distance the SR901 from the radiation fin. When a soldering iron of the 30 watts class is used and the body is warmed up too much, the devices themselves may be damaged. Take care not to apply heat for a long period of time.

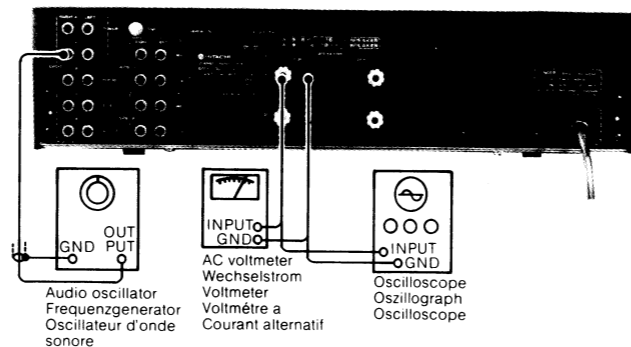

Fig. 6  
Abb. 6

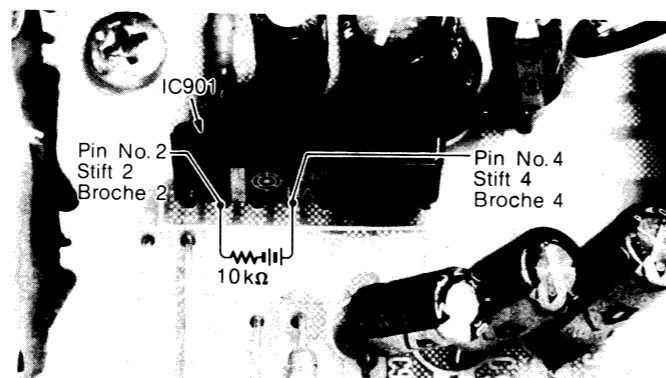

Fig. 7  
Abb. 7

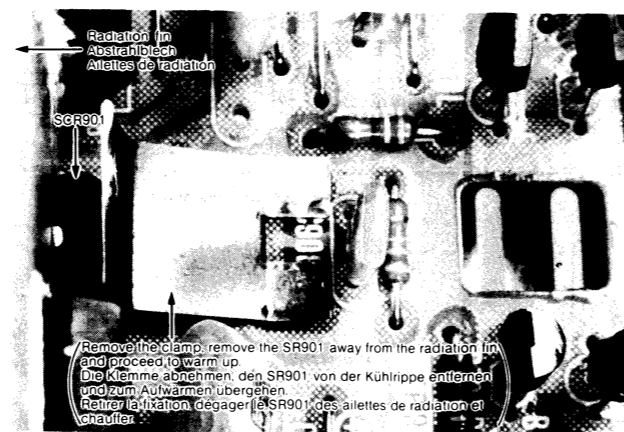

Fig. 8  
Abb. 8

### • Phenomena and remedy when the protection circuit operates

Type of protection circuit	Phenomenon when the protection circuit operates	Cause	Remedy
1 Muting circuit	No sound comes out about 7 – 10 sec. after the power switch is turned ON.	_____	Normal
2 Protection circuit of the output transistors	1. No sound comes out. 2. When the power switch is turned ON, the relay becomes ON, then OFF when the signal is applied.	Short circuit of speaker output terminal.	Turn off the power switch, check whether the speaker terminal is short circuited or not, and turn ON again.
3 Speaker protection circuit (DC voltage detection/protection circuit)	1. No sound comes out. 2. Neutral point voltage is more than $\pm 2$ V. 3. After the power switch is turned ON, relay doesn't turn ON.	Power amplifier faulty, etc.	1. Repair faulty parts in power amplifier.
4 Temperature-detection protection circuit	1. Sound suddenly stops when used for a long time.	1. Poor heat dissipating effect. 2. Speaker impedance is too low.	1. Improve heat dissipating effect. 2. Use speakers with an impedance of not less than 6 ohms or avoid use at sound volume levels.

## KONTROLLE DER FUNKTION DER SCHUTZSCHALTUNG

Falls die Ausgangsschaltung repariert wurde, indem z.B. die Ausgangstransistoren usw. erneuert wurden, dann müssen die Ausgangstransistoren der ASO-Schutzschaltung (ASO = Area of Safe Operation) und die Tätigkeit der Lautsprecher-Schutzschaltung wie nachfolgend beschrieben kontrolliert werden.

### 1. Funktionsprüfung der ASO-Schaltung für die Ausgangstransistoren

Den Frequenzoszillator an die TUNER IN anschließen, wobei die Lautsprecherklemmen keine Last aufweisen dürfen (Lautsprecher nicht angeschlossen). Die Frequenz des Frequenzoszillators auf 1 kHz einstellen und den Pegel des Eingangssignales so abgleichen, daß die Spannung an den Lautsprecherklemmen etwa 5 V (Mittelwert, bewertet) beträgt. In diesem Zustand sind die Lautsprecherklemmen kurzzuschließen, und zwar die Klemmen jenes Kanals, an welchen das Eingangssignal angelegt wurde. Falls dieser Kurzschluß zu einem Ansprechen der ASO-Schutzschaltung führt, dann erscheint kein Ausgangssignal an den Lautsprecherklemmen, auch nicht wenn den zum Kurzschließen der Klemmen verwendete Draht entfernt wird.

Danach den Netzschalter abschalten und nach etwa 10 Sekunden wieder einschalten. Wenn nun ein Ausgangssignal an den Lautsprecherklemmen festgestellt wird bedeutet dies, daß die ASO-Schutzschaltung richtig arbeitet.

### 2. Funktionsprüfung der Lautsprecher-Schutzschaltung

Darauf achten, daß etwa 7 – 10 Sekunden nach dem Einschalten des Netzschalters ein Schaltgeräusch des Relais vernommen werden kann, wenn keine Last an den Lautsprecherklemmen anliegt (Lautsprecher nicht angeschlossen).

Wenn ein Widerstand mit einem Widerstand von ca. 10 kOhm und zwei 1,5 V Trockenbatterien in Serie mit Stift 4 und Stift 2 von IC901 der gedruckten Schaltung parallelgeschaltet werden, wonach das

Relais innerhalb einer Sekunde abschalten sollte. Werden die Trockenbatterien wieder entfernt, dann arbeitet das Relais wiederum. Anschließend die Polarität der Trockenbatterien umpolen und die obige Prüfung des Relais nochmals durchführen. Wenn auch nun das Relais aktiviert wird, dann ist die Lautsprecher-Schutzschaltung in Ordnung. Bei dieser Prüfung ist besonders darauf zu achten, daß keine der benachbarten Teile kurzgeschlossen werden.

Wird das Relais dadurch erregt, bedeutet es, daß die Schutzschaltkreise der Lautsprecher normal funktionieren.

Wenn diese Funktionsprüfung vorgenommen wird, darauf achten, daß keine Kurzschlüsse mit naheliegenden Teilen entstehen.

### 3. Funktionsprüfung des Wärmeentdeckungsschaltkreises

Die Lautsprecher ohne Belastung getrennt lassen, den Netzschalter einschalten und überprüfen, daß nach 7 bis 10 Sekunden durch Erregen des Relais ein Knackgeräusch gehört wird.

Danach den Körper des SCR901 mit einem LötKolben oder Haartrockner anwärmen. Wenn die Temperatur des Körpers mindestens 100°C erreicht, wird der Schutzkreis aktiviert und das Relais ausgeschaltet. Selbst wenn der Körper nicht weiter erwärmt wird, erfolgt keine Rückstellung des Relais. Als nächstes den Netzschalter ausschalten, und nachdem sich der Körper genügend abgekühlt hat, das Gerät wieder einschalten. Wird das Relais erregt, bedeutet es, daß der Wärmeentdeckungsschutzschaltkreis normal funktioniert.

### VORSICHT

Vor dem Erwärmen des Körpers die Klemme abnehmen und den SCR-901 von der Strahlungsrippe entfernen. Bei Verwendung eines LötKolbens der 30 Watt-Klasse, und wenn der Körper zu stark erwärmt wird, könnten die Mechanismen selbst beschädigt werden. Darauf achten, daß Wärme nicht zu lange zugeführt wird.

• Ursachen für das Ansprechen der Schutzschaltung und etwaige Abhilfen

	Schutzschaltung	Wirkung, wenn die Schutzschaltung anspricht	Ursache	Abhilfe
1	Muting- Schaltkreis	Kein Ton von den Lautsprechern bis etwa 7 bis 10 Sekunden nach dem Einschalten des Netzschalters.	_____	Normal
2	Schutzstromkreis für die Ausgangstransistoren.	1. Kein Ton. 2. Nachdem der Netzschalter eingeschaltet wurde, spricht das Relais an; es wird wieder angeschaltet, sobald ein Signal eingegeben wird.	Kurzschluß an den Lautsprecherklemmen	Netzschalter abschalten, auf Kurzschluß an den Lautsprecherklemmen achten und diesen ggf. beheben, danach wieder einschalten.
3	Lautsprecher-Schutzschaltung	1. Kein Ton. 2. Nullpunktspannung beträgt mehr als $\pm 2$ V. 3. Wenn der Netzschalter eingeschaltet wird, spricht das Relais nicht an.	Endstufe schadhaft usw.	1. Die schadhafte Teile der Endstufe reparieren.
4	Wärmeentdeckungs-Schutzschaltkreis	1. Nach langem Betrieb hört der Klang plötzlich auf.	1. Unzureichende Wärmeabstrahlung. 2. Lautsprecherimpedanz ist zu gering.	1. Wärmeabstrahlung verbessern. 2. Lautsprecher mit einer Impedanz von nicht weniger als 6 Ohm verwenden oder nicht bei hohen Lautstärkepegeln betreiben.

CONTRÔLE DE FONCTIONNEMENT DU CIRCUIT DE PROTECTION

Quand le circuit de sortie est réparé à la suite du remplacement des transistors de sortie, etc., effectuer une vérification de fonctionnement du circuit de détection ASO (Zone d'Opération Protégée) pour transistors de sortie et du circuit de protection de haut-parleur.

1. Contrôle de fonctionnement du circuit de détection ASO pour les transistors de sortie

Brancher un oscillateur d'onde sonore aux bornes TUNER IN quand aucune charge n'est appliquée aux bornes de haut-parleur (haut-parleur débranché). Régler la fréquence de l'oscillateur d'onde sonore à 1 kHz et ajuster le niveau du signal d'entrée de telle sorte que la tension appliquée aux bornes de haut-parleur soit environ de 5 V efficace. Quand ces conditions sont obtenues, court-circuiter les bornes de haut-parleur du canal recevant le signal d'entrée en se servant d'un fil de jonction, etc. Si le court-circuit met le circuit de détection de type ASO en fonction, aucune sortie n'est relevée aux bornes de haut-parleur même si le fil de jonction utilisé pour le court-circuitage est retiré.

Ensuite, mettre l'interrupteur général à l'arrêt et après un délais approximatif de 10 secondes, le mettre à nouveau en fonction. Quand la sortie parvient aux bornes de haut-parleur, c'est le signe que le circuit de détection de type ASO fonctionne normalement.

2. Contrôle de fonctionnement du circuit de protection de haut-parleur

S'assurer que le relais fonctionne (un déclic se produit) environ 7 - 10 secondes après la mise en fonction de l'interrupteur général quand les bornes de haut-parleur ne reçoivent aucune charge (haut-parleur débranché). Lorsqu'une résistance d'environ 10 kilohms et deux piles de 1,5 V sont connectées en

série aux broches 4 et 2 de la plaquette imprimée IC901 d'ampli principal, le relais se met hors fonction en moins d'une seconde. Quand les piles sèches sont retirés le relais se remet une nouvelle fois en fonction.

Ensuite, modifier les polarités des piles sèches et procéder au contrôle précédemment décrit pour s'assurer que le fonctionnement du relais est normal. Si ces conditions permettent au relais de se mettre en fonction, cela veut dire que le circuit de protection de haut-parleur fonctionne normalement. Par ailleurs, faire attention de ne pas court-circuiter les pièces et composants avoisinants au cours de ce contrôle. Si le relai est énergétisé par cette opération, c'est la preuve que les circuits de protection des enceintes fonctionnent normalement.

Lorsque l'on procède à cet essai de fonctionnement, prendre soin à ne pas provoquer un court-circuit avec les pièces voisines.

3. Essai de fonctionnement du circuit de détection thermique

Laisser les haut-parleurs débranchés et sans charge; allumer l'interrupteur d'alimentation (ON) et s'assurer qu'un déclic se fait entendre par le relai énergétisé après 7 à 10 secondes.

Ensuite, chauffer le châssis du SCR901 à l'aide d'un fer à souder ou d'un sèche-cheveux. Une fois que la température dépasse 100°C, le circuit de protection est actualisé et le relai est coupé (OFF). Ce relai ne se réarme pas, même si le châssis de l'appareil n'est plus chauffé. Ensuite, placer sur OFF l'interrupteur d'alimentation et, après avoir laissé refroidir suffisamment le châssis, replacer l'appareil sous tension (ON). Si le relai est alors énergétisé, c'est le signe que le circuit de détection de température fonctionne normalement.

PRÉCAUTION

Avant de chauffer le châssis, détacher la bride et écarter le SR901 des ailettes de radiation. Si l'on utilise un fer à souder de la classe des 30 watts et que le châssis est chauffé trop fort, les dispositifs internes aux-mêmes risquent d'être endommagés. Dès lors, veiller à ne pas chauffer trop pendant trop longtemps.

• Phénomène et remède à apporter quand le circuit de protection est mis en fonction.

Type de circuit de protection	Phénomène produit quand le circuit de protection est mis en fonction.	Cause	Remède
1	Circuit de réglage silencieux	_____	Condition normale
2	Circuit de protection des transistors de sortie.	1. Aucun son n'est obtenu. 2. Dès que l'interrupteur general est réglé sur ON, le relais est mis sous tension puis est mis à l'arrêt quand le signal est appliqué.	Court-circuit des bornes de sortie d'enceinte  Mettre l'interrupteur général à l'arrêt, s'assurer que les bornes d'enceinte ne sont pas court-circuitées et remettre sous tension.
3	Circuit de protection d'enceinte	1. Aucun son n'est obtenu. 2. La tension de masse est supérieure à $\pm 2$ V. 3. Dès que l'interrupteur général est réglé sur ON, le relais n'est pas mis sous tension.	Panne d'ampli de puissance, etc.  1. Réparer les pièce endommagées de l'ampli de puissance.
4	Circuit protecteur à détection de température	1. Le son s'arrêt brusquement lors d'un emploi prolongé.	1. Effet de dissipation thermique insuffisant. 2. L'impédance de haut-parleur est trop faible.  1. Améliorer l'effet de dissipation thermique. 2. Se servir de haut-parleurs dont l'impédance n'est pas inférieure à 6 ohms ou éviter les forts niveaux de volume.

BLOCK DIAGRAM • BLOCK SCHEMA • SCHEMA

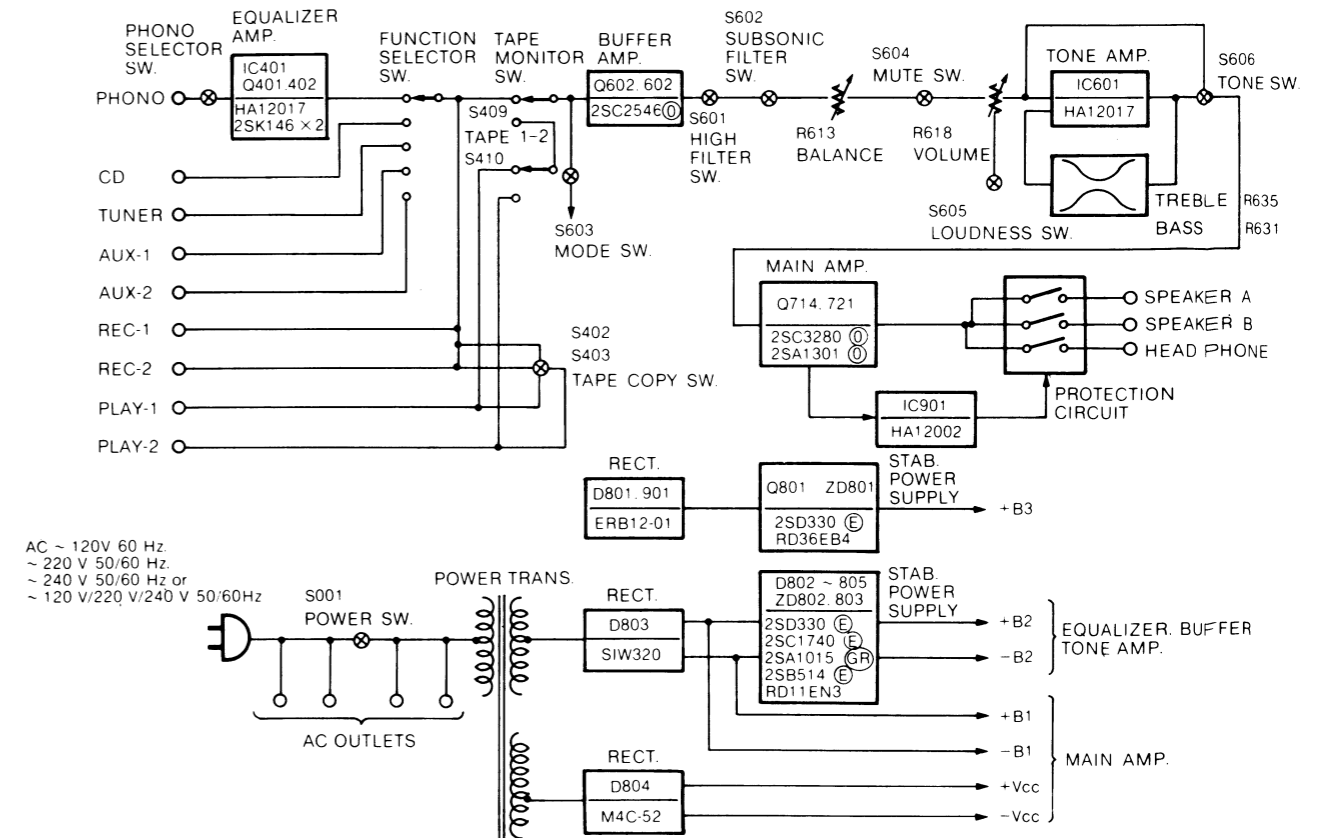

REPLACEMENT PARTS LIST • ERSATZTEILLISTE • TABLEAU DES PIECE

SYMBOL No.	PART No.	DESCRIPTION			
<b>CAPACITORS</b>					
(for AD P.W.B.)					
C001	0243901	Ceramic, discal	0.01μF	+100% -0% 400V	
C002	0243901	Ceramic, discal	0.01μF	+100% -0% 400V	
(except U.S.A. & Canada)					
C401LR	0230036	Cylindrical ceramic (for W. Germany)	100pF	±5% 50V	
C406LR	0230036	Cylindrical ceramic (for W. Germany)	100pF	±5% 50V	
C413	0240108	Cylindrical ceramic (for W. Germany)	0.022μF	±30% 16V	
C414LR	0230036	Cylindrical ceramic (for W. Germany)	100pF	±5% 50V	
C415LR	0240012	Cylindrical ceramic	0.001μF	±10% 50V	
C416LR	0230036	Cylindrical ceramic	100pF	±5% 50V	
C418LR	0240101	Cylindrical ceramic	0.0015μF	±30% 50V	
C419LR	0252242	Electrolytic	2200μF	6.3V	
C421LR	0272016	Mylar, film	0.018μF	±1% 50V	
C422LR	0272002	Mylar, film	0.0012μF	±1% 50V	
C423LR	0272723	Mylar, film	0.068μF	±1% 50V	
C424LR	0272002	Mylar, film	0.0012μF	±1% 50V	
C425LR	0240008	Cylindrical ceramic	470pF	±10% 50V	
C426LR	0240008	Cylindrical ceramic	470pF	±10% 50V	
C427LR	0252615	Electrolytic	4.7μF	25V	
C429LR	1274234	Mylar, film	0.0039μF	±5% 50V	
C430LR	0208688	Ceramic, discal	150pF	±5% 50V	
C431	0252632	Electrolytic	220μF	25V	
C433	0252632	Electrolytic	220μF	25V	
C702LR	0276011	Mylar, film	0.1μF	±10% 50V	
C703LR	0230036	Cylindrical ceramic	100pF	±5% 50V	
C704LR	0240008	Cylindrical ceramic	470pF	±10% 50V	
C705LR	0252232	Electrolytic	220μF	6.3V	
C706LR	0252232	Electrolytic	220μF	6.3V	
C707	0240012	Cylindrical ceramic (for W. Germany)	0.001μF	±10% 50V	
C708	0240012	Cylindrical ceramic (for W. Germany)	0.001μF	±10% 50V	
C708	0252932	Electrolytic	220μF	16V	
C709	0240012	Cylindrical ceramic (for W. Germany)	0.001μF	±10% 50V	
C710	0240012	Cylindrical ceramic (for W. Germany)	0.001μF	±10% 50V	
C710LR	0247811	Ceramic, discal	1pF	±10% 500V	
C711	0240012	Cylindrical ceramic (for W. Germany)	0.001μF	±10% 50V	
C711LR	0247892	Ceramic, discal	82pF	±10% 500V	
C712	0240012	Cylindrical ceramic (for W. Germany)	0.001μF	±10% 50V	
C712LR	0247811	Ceramic, discal	1pF	±10% 500V	
C713LR	0230036	Cylindrical ceramic	100pF	±5% 50V	
C714LR	0247851	Ceramic, discal	75pF	±5% 500V	
C715LR	0279211	Mylar, film	0.1μF	±10% 250V	
C716LR	0230036	Cylindrical ceramic	100pF	±5% 50V	
C717LR	0247851	Ceramic, discal	75pF	±5% 500V	
C718LR	0276511	Mylar, film	0.1μF	±10% 100V	
C719LR	0276511	Mylar, film	0.1μF	±10% 100V	
C720LR	0275515	Mylar, film	0.047μF	±10% 100V	
C721LR	0209173	Ceramic, discal (for W. Germany)	0.022μF	+80% -20% 50V	
C722LR	0209173	Ceramic, discal	0.022μF	+80% -20% 50V	
C724LR	0230036	Cylindrical ceramic	100pF	±5% 50V	
C725LR	0240006	Cylindrical ceramic	330pF	±10% 50V	
C726LR	0240006	Cylindrical ceramic	330pF	±10% 50V	
C728	0252811	Electrolytic	1μF	50V	
C729	0252811	Electrolytic	1μF	50V	
C730	0252811	Electrolytic	1μF	50V	
C802	0275511	Mylar, film (for France, Switzerland, Sweden, & W. Germany)	0.01μF	±10% 100V	
C803	0245408	Ceramic, discal	0.01μF	±20% 500V	
C804	0252932	Electrolytic	220μF	63V	
C805	0245408	Ceramic, discal	0.01μF	±20% 500V	
C806	0275511	Mylar, film (for France, Switzerland, Sweden & W. Germany)	0.01μF	±10% 100V	
C807	0279291	Mylar, film	0.01μF	±10% 630V	
C808	0279291	Mylar, film	0.01μF	±10% 630V	
C809	0259987	Electrolytic	12000μF	63V	
C810	0259987	Electrolytic	12000μF	63V	
C811	0279291	Mylar, film	0.01μF	±10% 630V	
C812	0279291	Mylar, film	0.01μF	±10% 630V	
C813	0252942	Electrolytic	2200μF	63V	
C815	0252731	Electrolytic	100μF	35V	
C818	0252531	Electrolytic	100μF	16V	
C819	0252942	Electrolytic	2200μF	63V	
C821	0252731	Electrolytic	100μF	35V	
C824	0252531	Electrolytic	100μF	16V	
C825	0252822	Electrolytic	22μF	50V	
C828	0276513	Mylar, film	0.22μF	±10% 100V	
C901	0252231	Electrolytic	100μF	6.3V	
C902	0252331	Electrolytic	100μF	10V	
C903	0252811	Electrolytic	1μF	50V	
C904	0252521	Electrolytic	10μF	16V	
C905	0252232	Electrolytic	220μF	6.3V	
C906	0252811	Electrolytic	1μF	50V	
C908	0275011	Mylar, film	0.01μF	±10% 50V	
(for PA P.W.B.)					
C601LR	0252811	Electrolytic	1μF	50V	
C602LR	0230028	Cylindrical ceramic	47pF	±5% 50V	
C604	0252632	Electrolytic	220μF	25V	
C606	0252632	Electrolytic	220μF	25V	
C608LR	0252621	Electrolytic	10μF	25V	
C609LR	0275034	Mylar, film	0.039μF	±10% 50V	
C610LR	0252811	Electrolytic	1μF	±20% 50V	
C611LR	0276013	Cylindrical ceramic	0.0022μF	±30% 50V	
C612LR	0276013	Mylar, film	0.22μF	±10% 50V	
C613LR	0240101	Mylar, film	0.22μF	±10% 50V	
C614LR	0230028	Cylindrical ceramic	47pF	±5% 50V	
C615LR	0240101	Cylindrical ceramic	0.0015μF	±30% 50V	
C617	0252632	Electrolytic	220μF	25V	
C619	0252632	Electrolytic	220μF	25V	

SYMBOL No.	PART No.	DESCRIPTION			
C620LR	0252521	Electrolytic	10μF	±10% 16V	
C621LR	0275015	Mylar, film	0.047μF	±10% 50V	
C622LR	0276811	Mylar, film	0.1μF	±10% 50V	
C623LR	0276811	Mylar, film	0.1μF	±10% 50V	
C624LR	0252812	Electrolytic	2.2μF	±5% 50V	
C625LR	0230037	Cylindrical ceramic	120pF	±5% 50V	
C626LR	0274015	Mylar, film	0.0047μF	±10% 50V	
C627LR	0275033	Mylar, film	0.027μF	±10% 50V	
C628LR	0252813	Electrolytic	3.3μF	±5% 50V	
C629LR	0230036	Cylindrical ceramic	100pF	±5% 50V	
C630LR	0240008	Cylindrical ceramic	470pF	±10% 50V	
C631LR	0252625	Electrolytic	47μF	25V	
C632LR	0240101	Cylindrical ceramic	0.0015μF	±30% 50V	
C633	0274011	Mylar, film	0.001μF	±10% 50V	
C634	0274011	Mylar, film	0.001μF	±10% 50V	
C636LR	0246494	Ceramic, discal	100pF	±10% 50V	
C637LR	0252811	Electrolytic	1μF	50V	
C639LR	0230036	Cylindrical ceramic	100pF	±5% 50V	
C723LR	0209173	Ceramic, discal (for W. Germany)	0.022μF	+80% -20% 50V	
C727	0252811	Electrolytic	1μF	50V	
<b>RESISTORS</b>					
(for AD P.W.B.)					
R401LR	0129601	Carbon film (for W. Germany)	1kΩ	±5% SRD1/4P	
R406LR	0129601	Carbon film (for W. Germany)	1kΩ	±5% SRD1/4P	
R407LR	0129605	Carbon film	1.5kΩ	±5% SRD1/4P	
R408LR	0129561	Carbon film	100Ω	±5% SRD1/4P	
R409LR	0129647	Carbon film	4.7kΩ	±5% SRD1/4P	
R410LR	0129613	Carbon film	3.3kΩ	±5% SRD1/4P	
R411LR	0129613	Carbon film	3.3kΩ	±5% SRD1/4P	
R412LR	0129573	Carbon film	330Ω	±5% SRD1/4P	
R413LR	0129611	Carbon film	2.7kΩ	±5% SRD1/4P	
R414LR	0129552	Carbon film	75Ω	±5% SRD1/4P	
R415LR	0129523	Carbon film	8.2Ω	±5% SRD1/4P	
R416LR	0129647	Carbon film	4.7kΩ	±5% SRD1/4P	
R417LR	0118915	Metal	3.9kΩ	±1% RN1/4B	
R418LR	0118939	Metal	22kΩ	±1% RN1/4B	
R419LR	0118940	Metal	24kΩ	±1% RN1/4B	
R420LR	0129551	Carbon film	68Ω	±5% SRD1/4P	
R421LR	0129605	Carbon film	1.5kΩ	±5% SRD1/4P	
R422LR	0129579	Carbon film	560Ω	±5% SRD1/4P	
R423LR	0129661	Carbon film	100kΩ	±5% SRD1/4P	
△R424	0110625	Metal(fuse resistor)	150Ω	±5% RN1/4B	
△R425	0110625	Metal(fuse resistor)	150Ω	±5% RN1/4B	
R434LR	0129533	Carbon film (for W. Germany)	12Ω	±5% SRD1/4P	
R435LR	0129601	Carbon film (for W. Germany)	1kΩ	±5% SRD1/4P	
R644LR	0129667	Carbon film	180kΩ	±5% SRD1/4P	
R701LR	0129605	Carbon film	1.5kΩ	±5% SRD1/4P	
R702LR	0129669	Carbon film	220kΩ	±5% SRD1/4P	
R703LR	0129561	Carbon film	100Ω	±5% SRD1/4P	
R704LR	0129561	Carbon film	100Ω	±5% SRD1/4P	
R705LR	0129565	Carbon film	150Ω	±5% SRD1/4P	
R706	0134385	Composition	10kΩ	±10% RC1/2GF	
R707LR	0129581	Carbon film	680Ω	±5% SRD1/4P	
R708LR	0129609	Carbon film	2.2kΩ	±5% SRD1/4P	
R709LR	0129603	Carbon film	1.2kΩ	±5% SRD1/4P	
R710LR	0129669	Carbon film	220kΩ	±5% SRD1/4P	
R711	0119545	Metal oxide	2.2kΩ	±10% RS2B	
R712LR	0129647	Carbon film	4.7kΩ	±5% SRD1/4P	
△R713LR	0110622	Metal(fuse resistor)	120Ω	±5% SRD1/4P	
R714LR	0129647	Carbon film	4.7kΩ	±5% SRD1/4P	
R715LR	0129609	Carbon film	2.2kΩ	±5% SRD1/4P	
R716LR	0129531	Carbon film	10Ω	±5% SRD1/4P	
R717LR	0129581	Carbon film	680Ω	±5% SRD1/4P	
R718LR	0129613	Carbon film	3.3kΩ	±5% SRD1/4P	
R719LR	0129615	Carbon film	3.9kΩ	±5% SRD1/4P	
△R720LR	0110627	Metal(fuse resistor)	330Ω	±5% RN1/4B	
△R721LR	0110628	Metal(fuse resistor)	390Ω	±5% RN1/4B	
△R722LR	0110627	Metal(fuse resistor)	330Ω	±5% RN1/4B	
R723LR	0119123	Metal	0.22Ω	±10% RN2B	
R724LR	0129621	Carbon film	6.8kΩ	±5% SRD1/4P	
R725LR	0129643	Carbon film	3.3kΩ	±5% SRD1/4P	
R726LR	0129631	Carbon film	10kΩ	±5% SRD1/4P	
R727LR	0119562	Metal oxide	12kΩ	±10% RS2B	
R728LR	0129579	Carbon film	560Ω	±5% SRD1/4P	
△R730LR	0110621	Metal(fuse resistor)	100Ω	±5% RN1/4B	
△R731LR	0110621	Metal(fuse resistor)	100Ω	±5% RN1/4B	
R732LR	0129531	Carbon film	10Ω	±5% SRD1/4P	
R733LR	0129581	Carbon film	680Ω	±5% SRD1/4P	
R734LR	0129613	Carbon film	3.3kΩ	±5% SRD1/4P	
R735LR	0129615	Carbon film	3.9kΩ	±5% SRD1/4P	
△R736LR	0110627	Metal(fuse resistor)	330Ω	±5% RN1/4B	
△R737LR	0110627	Metal(fuse resistor)	330Ω	±5% RN1/4B	
R738LR	0119123	Metal	0.22Ω	±10% RN2B	
R739LR	0129683	Carbon film	830kΩ	±5% SRD1/4P	
R740LR	0129661	Carbon film	100kΩ	±5% SRD1/4P	
R741LR	0129651	Carbon film	6.8kΩ	±5% SRD1/4P	
R742LR	0134289	Composition	10Ω	±10% RC1/2GF	
R743LR	0119501	Metal oxide	10Ω	±10% RS2B	
R744LR	0134364	Composition	180Ω	±10% RC1/2GF	
R745LR	0134364	Composition	180Ω	±10% RC1/2GF	
R746	0129581	Carbon film	680Ω	±5% SRD1/4P	
R747	0129661	Carbon film	100kΩ	±5% SRD1/4P	
R754	0129368	Composition	390Ω	±10% RC1/2GF	
R755	0129368	Composition	390Ω	±10% RC1/2GF	
R756	0134375	Composition	1.5kΩ	±10% RC1/2GF	
R757LR	0129617	Carbon film	4.7kΩ	±5% SRD1/4P	
R758LR	01296				

SYMBOL No.	PART No.	DESCRIPTION			SYMBOL No.	PART No.	DESCRIPTION	
(for PA P.W.B.)					ICS & TRANSISTORS			
R426LR	0129601	Carbon film	1kΩ	±5%	SRD1/4P	(for AD P.W.B.)		
}	}	}	}	}	}			
R429LR	0129601	Carbon film	1kΩ	±5%	SRD1/4P	IC401LR	2367871	HA-12017
R430LR	0129619	Carbon film	5.6kΩ	±5%	SRD1/4P	IC901	2367372	HA-12002
R433	0134377	Composition	2.2kΩ	±10%	RC1/2GF	Q401LR	2317863	FET 2SK146
R434	0134379	Composition	3.3kΩ	±10%	RC1/2GF	Q701LR	2329183	2SA1015 (GR)
R435	0129575	Carbon film	390Ω	±5%	SRD1/4P	Q702LR	2328783	2SC2389 (E)
R436	0134379	Composition	3.3kΩ	±10%	RC1/2GF	Q703LR	2328783	2SC2389 (E)
R437	0129575	Carbon film	390Ω	±5%	SRD1/4P	Q704LR	2317863	FET 2SK146
R438LR	0129683	Carbon film	820kΩ	±5%	SRD1/4P	Q705LR	2328783	2SC2389 (E)
R439LR	0129683	Carbon film	820kΩ	±5%	SRD1/4P	Q706LR	2328745	2SB648A (C)
R440LR	0129683	Carbon film	820kΩ	±5%	SRD1/4P	Q707LR	2328745	2SB648A (C)
R601LR	0129661	Carbon film	100kΩ	±5%	SRD1/4P	C708LR	2328783	2SC2389 (E)
R602LR	0129531	Carbon film	10Ω	±5%	SRD1/4P	Q709LR	2328755	2SD668A (C)
R603LR	0129661	Carbon film	100kΩ	±5%	SRD1/4P	Q710LR	2327913	2SC1775 (E)
R604LR	0129617	Carbon film	4.7kΩ	±5%	SRD1/4P	Q711LR	2327913	2SC1775 (E)
R605LR	0129561	Carbon film	100Ω	±5%	SRD1/4P	Q712LR	2328755	2SD668A (C)
R606LR	0129561	Carbon film	100Ω	±5%	SRD1/4P	Q713LR	2328465	2SD669A (C)
R607	0110627	Carbon film	330Ω	±5%	RN1/4B	Q714LR	2317912	2SC3280 (O)
△R608	0110625	Metal(fuse resistor)	220Ω	±5%	RN1/4B	Q715LR	2328872	2SD756A (E)
R609LR	0129661	Carbon film	100kΩ	±5%	SRD1/4P	Q716LR	2328755	2SD668A (C)
R610LR	0129579	Carbon film	560Ω	±5%	SRD1/4P	Q717LR	2328893	2SA872 (E)
R611LR	0129661	Carbon film	100kΩ	±5%	SRD1/4P	Q718LR	2328893	2SA872 (E)
R612LR	0129631	Carbon film	10kΩ	±5%	SRD1/4P	Q719LR	2328745	2SB648A (C)
R614LR	0129621	Carbon film	6.8kΩ	±5%	SRD1/4P	Q720LR	2328475	2SB649A (C)
R615LR	0129583	Carbon film	820Ω	±5%	SRD1/4P	Q721LR	2317902	2SA1301 (O)
R616LR	0129603	Carbon film	1.2kΩ	±5%	SRD1/4P	Q722	2329183	2SA1015 (GR)
R617LR	0129577	Carbon film	470Ω	±5%	SRD1/4P	Q801	2317732	2SD330 (E)
R619LR	0129577	Carbon film	470Ω	±5%	SRD1/4P	Q802	2317738	2SD330AL (E)
R620LR	0129669	Carbon film	220kΩ	±5%	SRD1/4P	Q803	2328653	2SC1740LN (E)
R621LR	0129615	Carbon film	3.9kΩ	±5%	SRD1/4P	Q804	2329183	2SA1015 (GR)
R622LR	0129573	Carbon film	330Ω	±5%	SRD1/4P	Q805	2328963	2SA514AL (E)
R623LR	0129617	Carbon film	4.7kΩ	±5%	SRD1/4P	(for PA P.W.B.)		
R624LR	0129617	Carbon film	4.7kΩ	±5%	SRD1/4P	IC601LR	2367871	HA12017
△R625	0110625	Metal(fuse resistor)	220Ω	±5%	RN1/4B	Q601LR	2329863	FET μPA68H
△R626	0110625	Metal(fuse resistor)	220Ω	±5%	RN1/4B	Q601LR	2329152	2SC2546 (E)
R627LR	0129647	Carbon film	47kΩ	±5%	SRD1/4P	Q602LR	2329152	2SC2546 (E)
R628LR	0129583	Carbon film	820Ω	±5%	SRD1/4P	Q723	2329183	2SA1015 (GR)
R629LR	0129561	Carbon film	100Ω	±5%	SRD1/4P	Q724	2329183	2SA1015 (GR)
R630LR	0129607	Carbon film	1.8kΩ	±5%	SRD1/4P	DIODES		
R632LR	0129647	Carbon film	47kΩ	±5%	SRD1/4P	(for AD P.W.B.)		
R633LR	0129633	Carbon film	12kΩ	±5%	SRD1/4P	D401LR	2337601	1S2473
R634LR	0129619	Carbon film	5.6kΩ	±5%	SRD1/4P	D402LR	2337601	1S2473
R636LR	0129581	Carbon film	680Ω	±5%	SRD1/4P	D701LR	2337601	1S2473
R637LR	0129647	Carbon film	47kΩ	±5%	SRD1/4P	}	}	}
R638LR	0129605	Carbon film	1.5kΩ	±5%	SRD1/4P	D704LR	2337601	1S2473
R639LR	0129617	Carbon film	4.7kΩ	±5%	SRD1/4P	D705LR	2337151	1S2076A
R640LR	0129581	Carbon film	680Ω	±5%	SRD1/4P	D706LR	2337151	1S2076A
R641LR	0129647	Carbon film	47kΩ	±5%	SRD1/4P	D707LR	2337601	1S2473
R641	0134377	Composition	2.2kΩ	±10%	RC1/2GF	D708LR	2337151	1S2076A
R748	0129639	Carbon film	22kΩ	±5%	SRD1/4P	D709	2337151	1S2076A
R749	0129603	Carbon film	1.2kΩ	±5%	SRD1/4P	D710	2337151	1S2076A
R750	0129639	Carbon film	22kΩ	±5%	SRD1/4P	D711	2337151	1S2076A
R751	0129603	Carbon film	1.2kΩ	±5%	SRD1/4P			
R752	0129563	Carbon film	120Ω	±5%	SRD1/4P			
R753	0129563	Carbon film	120Ω	±5%	SRD1/4P			

# HITACHI HA-6

SYMBOL No.	PART No.	DESCRIPTION	SYMBOL No.	PART No.	DESCRIPTION
D801	2337762	ERB12-01R	△F001	2727897	Fuse - 6.3A UL TSC (for U.S.A. & Canada)
D802	2337762	ERB12-01R	△F001	2727196	Fuse - T3.15A (for France, Sweden, Switzerland, U.K. & Australia)
D803	2338721	S1WB20			
D804	2339971	M4C-52-13			
D901	2337762	ERB12-01R	△F802	2727891	Fuse - 1.6A UL TSC (for U.S.A. & Canada)
ZD701	2338626	RD12EN3	△F802	2727194	Fuse - 1.6A (for France, Sweden, Switzerland, U.K. & Australia)
ZD702	2338626	RD12EN3	△F803	2727891	Fuse - 1.6A UL TSC (for U.S.A. & Canada)
ZD801	2338666	RD36EB4	△F803	2727194	Fuse - 1.6A (for France, Sweden, Switzerland, U.K. & Australia)
ZD802	2338623	RD11EN3			
ZD803	2338623	RD11EN3			
(for PA P.W.B.)					
D403	2397052	LED SLH-34MC (3)	SCR901	2338861	TT201-90
}	}	}	TH701LR	2347113	Thermostat 112102-2
D417	2397052	LED SLH-34MC (3)	S401	2627512	SSR 2435 (MM/MC)
D418	2339103	LED SLH-34YC (4) (TAPE MONITOR COPY)		2678481	2P US pin jack
D419	2339103	LED SLH-34YC (4) (TAPE MONITOR COPY)		2678482	2P US pin jack (PHONE CD TUNER)
				4567414	3φ × 12 DT bind screw
				4784106	3φ × 10 bind tapping screw
				4578285	2.6φ × 10 DT screw
				4567414	3φ × 12 DT bind screw
				2688193	SP terminal
(for PA P.W.B.)					
D601LR	2336601	1S2473	S402	2639753	Push switch (COPY MONITOR)
D602	2397052	LED SLH-34MC (3)	S403	2639754	Push switch (COPY 1 → 2 TAPE 1 → 2)
}	}	}	S404	2639752	Push switch (FUNCTION)
D606	2397052	LED SLH-34MC (3)	}	}	}
D712	2397051	LED SLH-34VC (3) (red) (SPEAKER)	S408	2639752	Push switch (FUNCTION)
D713	2397051	LED SLH-34VC (3) (red) (SPEAKER)	S409	2639753	Push switch (COPY MONITOR)
			S410	2639754	Push switch (COPY 1 → 2 TAPE 1 → 2)
<b>VARIABLE RESISTORS</b>					
(for AD P.W.B.)					
R729LR	0150952	200Ω - (B)	S601	2639755	Push switch (HIGH LOW MODE)
			S602	2639755	Push switch (HIGH LOW MODE)
			S603	2639755	Push switch (HIGH LOW MODE)
			S604	2639756	Push switch (MUTE LOUDNESS)
			S605	2639756	Push switch (MUTE LOUDNESS)
			S606	2639757	Push switch (TONE)
(for PA P.W.B.)					
R613	0151637	100kΩ - (MN) (BALANCE)	S701	2639758	Push switch (S/P)
R618	0158831	10kΩ - (B) (MAIN VOLUME)	S702	2639758	Push switch (S/P)
R631	0151674	50kΩ - (C) (BASS)		2677752	HIP jack
R635	0151674	50kΩ - (C) (TREBLE)			
<b>COILS</b>			<b>for FINAL ASSEMBLY</b>		
(for AD P.W.B.)					
L401LR	2227371	Choke coil 47μH	3299121		Knob (44) ass'y
L402	2227396	Choke coil 10μH	3299041		Knob (14) ass'y
L403	2227396	Choke coil 10μH	3299011		Knob (6) ass'y
L701LR	2227371	Choke coil 47μH	3299092		2 × 8 push knob
L702LR	2227311	Trap coil 2.5μH	3299102		Push knob (T.C) (TAPE 1 → 2 COPY 1 → 2)
			3299061		Knob (M.C) ass'y (TAPE MONITOR)
			3299062		Knob (M.C) ass'y (TAPE COPY)
			3299201		Power button ass'y (POWER)
			4743856		Knob ring (VOLUME)
			4743853		Knob ring (BASS, TREBLE, BLANCE)
(for PA P.W.B.)					
L601	2227356	Choke coil	3299771		Knob (24) ass'y (PHONO)
L602	2227356	Choke coil	3299771		Knob (24) ass'y (TUNER)
			3299771		Knob (24) ass'y (CD)
			3299771		Knob (24) ass'y (AUX-1)
			3299771		Knob (24) ass'y (AUX-2)
			3961061		Flexible ring (FUNCTION)
<b>MISCELLANEOUS</b>					
(for AD P.W.B.)					
RY701	2647242	Miniature power relay			
RY702	2647242	Miniature power relay			
RY703	2647161	Lead relay			



SYMBOL No.	PART No.	DESCRIPTION	SYMBOL No.	PART No.	DESCRIPTION
	3961091	Side panel (L)		3944381	Outlet cap (for W. Germany)
	3961092	Side panel (R)		4567432	3φ × 8 DT bind screw (for W. Germany, Asia & Latin American countries, etc.)
	4024182	Escutcheon ass'y		<b>for DIAL MECHANISM ASSEMBLY</b>	
	4415586	Cover ass'y		3180091	23φ × 12 leg
	4744106	Screen		4567431	3φ × 6 DT bind screw
	4567411	3φ × 6 DT bind screw		4567411	3φ × 6 DT bind screw
	4567411	3φ × 6 DT bind screw		4575451	4φ × 8 DT bind screw with washer (L)
	4568811	3φ × 6 DT flat head screw		4575951	3φ × 6 DT bind screw with washer (L)
	4575451	4φ × 8 DT		4567414	3φ × 6 DT bind screw
	8815126	4 rock washer		4784106	3φ × 10 bind tapping screw
				4567451	3φ × 6 DT bind screw
<b>for REAR PLATE ASSEMBLY</b>				4567422	4φ × 8 DT bind screw
	4453732	Rear panel (for U.S.A.)		4567452	3φ × 8 DT bind screw
	4453733	Rear panel (for Canada)		3933805	Nilon rivet
	4453736	Rear panel (for France, Sweden & Switzerland)	△	2248492	Power trans. (for U.S.A. & Canada)
	4453734	Rear panel (for U.K. & Australia)	△	2248493	Power trans. (for France, Sweden & Switzerland)
	4453735	Rear panel (for W. Germany, Asia & Latin American countries, etc.)	△	2248494	Power trans. (for U.K. & Australia)
△	3913006	Bushing	△	2248495	Power trans. (for W. Germany, Asia & Latin American countries, etc.)
△	2700122	AC cord (for U.S.A. & Canada)		△ S001	2639394 Power switch
△	2748752	AC cord (for France, Sweden, Switzerland, W. Germany, Asia & Latin American countries, etc.)			2639981 Remote switch
△	2749582	AC cord (for U.K.)		<b>for ACCESSORIES</b>	
△	2749622	AC cord (for Australia)		3627411	Antenna cover
△	2658481	AC outlet (for U.S.A. & Canada)	△	2658361	E socket adaptor
△	2657741	AC outlet (CEE) (for France, Sweden & Switzerland)	△	2727581	Fuse T6.3A - 250V
△	2658372	AC outlet (for W. Germany, Asia & Latin American countries.)			
△	2727196	Fuse T3.15A - 250V (for W. Germany, Asia & Latin American countries, etc.)			
△	2618053	AC selector switch (for W. Germany, Asia & Latin American countries, etc.)			

Check that exposed parts are acceptably insulated from the supply circuit before returning the instrument repaired to the customer.

● **Checking method**

Power switch is set to ON.  
Next, measure the resistance value between the both poles of attachment cup (Power supply plug) and the exposed parts (Parts such as Ground terminal, Knob, Cover, etc. where the customer is easy to touch) and check that the resistance value is 500 kohms or more.

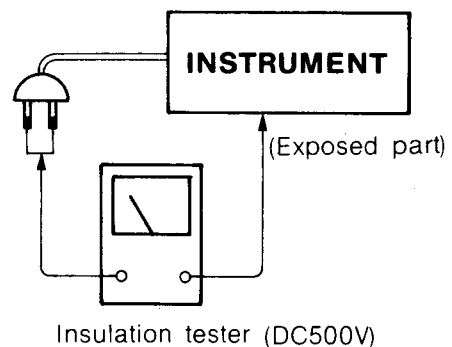

FRONT AND REAR PANEL. VORDERE UND HINTERE  
BEDIENUNGSTAFEL. PANNEAUX AVANT ET ARRIERE

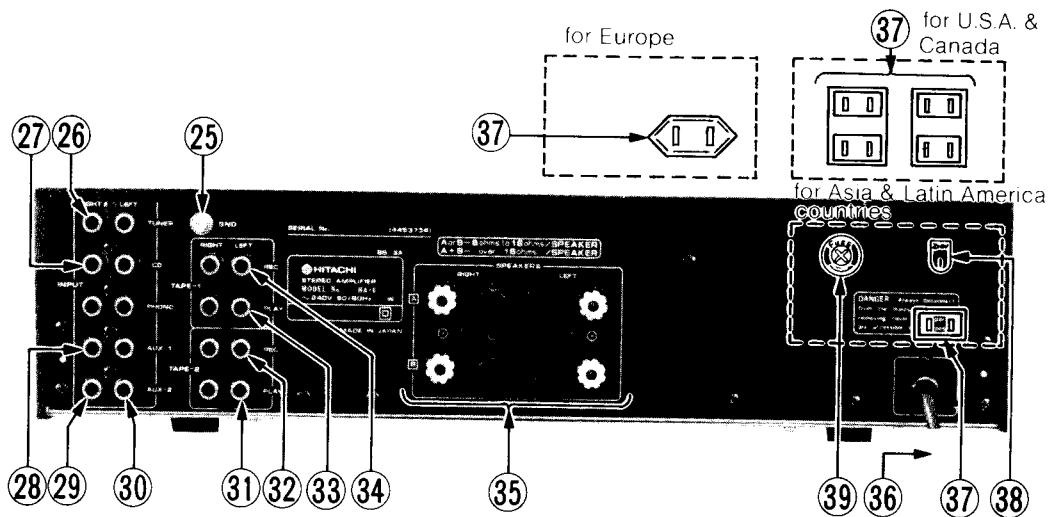
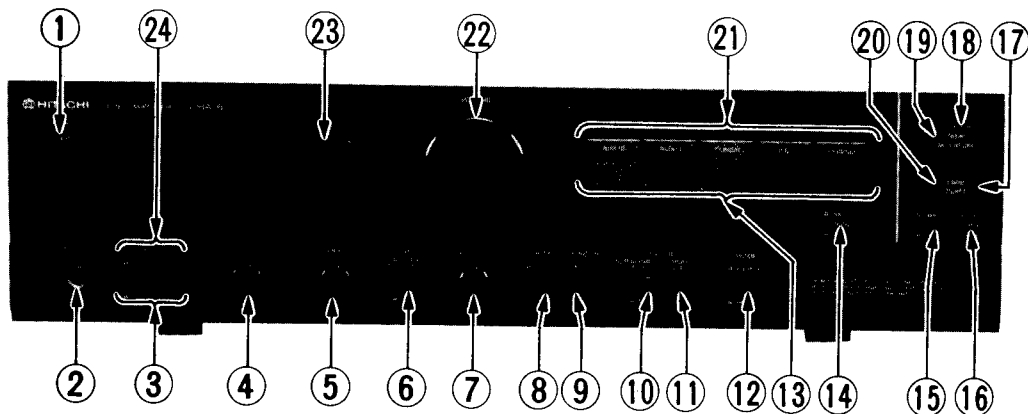

- ① Power switch (POWER)
- ② Phones jacks (PHONES)
- ③ Speakers switches (SPEAKERS)
- ④ Bass control (BASS)
- ⑤ Treble control (TREBLE)
- ⑥ Tone switch (TONE)
- ⑦ Balance control (BALANCE)
- ⑧ Mute switch (MUTE)
- ⑨ Loudness switch (LOUDNESS)
- ⑩ Subsonic-filter switch (SUBSONIC)
- ⑪ High-filter switch (HIGH)
- ⑫ Mode switch (MODE)
- ⑬ Function switches (FUNCTION)
- ⑭ Phono selector (PHONO)
- ⑮ Tape monitor select switch (TAPE MONITOR SELECT)
- ⑯ Tape copy select switch (TAPE COPY SELECT)
- ⑰ Tape copy switch (TAPE COPY)
- ⑱ Tape monitor switch (TAPE MONITOR)
- ⑲ Tape monitor indicator
- ⑳ Tape copy indicator
- ㉑ Function indicator
- ㉒ Volume control (VOLUME)
- ㉓ Pure Drive indicator (PURE DRIVE)
- ㉔ Speakers indicators

- ㉕ Ground terminal (GND)
- ㉖ Tuner input jacks (TUNER INPUT)
- ㉗ CD input jacks (CD INPUT)
- ㉘ Phono input jacks (PHONO INPUT)
- ㉙ AUX-1 input jacks (AUX-1 INPUT)
- ㉚ AUX-2 input jacks (AUX-2 INPUT)
- ㉛ Tape-2 play jacks (TAPE-2 PLAY)
- ㉜ Tape-2 rec jacks (TAPE-2 REC)
- ㉝ Tape-1 play jacks (TAPE-1 PLAY)
- ㉞ Tape-1 rec jacks (TAPE-1 REC)
- ㉟ Speakers terminals (SPEAKERS)
- ㊱ Power supply cord
- ㊲ AC outlet  
(4 outlets for U.S.A. & Canada sets,  
1 outlet for Europe, Asia & Latin  
American countries' sets)
- ㊳ Voltage selector (VOLTAGE)  
(for W. Germany, Asia & Latin American  
countries' sets)
- ㊴ Fuse holder  
(for W. Germany, Asia & Latin American  
countries' sets)

- |  |   |
|--|---|
| <ul style="list-style-type: none"> <li>① Netzschalter (POWER)</li> <li>② Kopfhörerbuchse (PHONES)</li> <li>③ Lautsprecherschalter (SPEAKERS)</li> <li>④ Tiefenregler (BASS)</li> <li>⑤ Höhenregler (TREBLE)</li> <li>⑥ Klangregler (TONE)</li> <li>⑦ Balanceregler (BALANCE)</li> <li>⑧ Dämpfungsschalter (MUTE)</li> <li>⑨ Lautstärkekonturschalter (LOUDNESS)</li> <li>⑩ Schalter für Unterschallfilter (SUBSONIC)</li> <li>⑪ Schalter für Hochfrequenzfilter (HIGH)</li> <li>⑫ Betriebsartschalter (MODE)</li> <li>⑬ Funktionsschalter (FUNCTION)</li> <li>⑭ Plattenspielerwähler (PHONO SELECTOR)</li> <li>⑮ Tonbandüberwachungs-Wahlschalter (TAPE MONITOR SELECT)</li> <li>⑯ Bandüberspielungs-Wahlschalter (TAPE COPY SELECT)</li> <li>⑰ Bandüberspielungsschalter (TAPE COPY)</li> <li>⑱ Tonbandüberwachungsschalter (TAPE MONITOR)</li> <li>⑲ Tonbandüberwachungsanzeige</li> <li>⑳ Tonbandüberspielungsanzeige</li> <li>㉑ Funktionsanzeigen</li> </ul> | <ul style="list-style-type: none"> <li>㉒ Lautstärkeregel (VOLUME)</li> <li>㉓ Betriebsanzeige</li> <li>㉔ Lautsprecheranzeigen</li> <li>㉕ Erdungsanschluß (GND)</li> <li>㉖ Tuner-Eingangsbuchsen (TUNER INPUT)</li> <li>㉗ CD-Eingangsbuchsen (CD INPUT)</li> <li>㉘ Phono-Eingangsbuchsen (PHONO INPUT)</li> <li>㉙ AUX-1-Eingangsbuchsen (AUX-1 INPUT)</li> <li>㉚ AUX-2-Eingangsbuchsen (AUX-2 INPUT)</li> <li>㉛ Tonband-2-Wiedergabebuchsen (TAPE-2 PLAY)</li> <li>㉜ Tonband-2-Aufnahmebuchse (TAPE-2 REC)</li> <li>㉝ Tonband-1-Wiedergabebuchsen (TAPE-1 PLAY)</li> <li>㉞ Tonband-1-Aufnahmebuchsen (TAPE-1 REC)</li> <li>㉟ Lautsprecher-Anschlüsse (SPEAKERS)</li> <li>㊱ Netzkabel</li> <li>㊲ Gleichstrom-Ausgangsanschluß (4 für USA und Kanada, 1 für Europa, Asien und Lateinamerika)</li> <li>㊳ Spannungswähler (für die Bundesrepublik Deutschland, Asien und Lateinamerika)</li> <li>㊴ Fuse holder (für die Bundesrepublik Deutschland, Asien und Lateinamerika)</li> </ul> |
|--|---|

- |   |  |
|---|--|
| <ul style="list-style-type: none"> <li>① Interrupteur d'alimentation (POWER)</li> <li>② Prises de casque d'écoute (PHONES)</li> <li>③ Interrupteur d'enceintes (SPEAKERS)</li> <li>④ Commande des graves (BASS)</li> <li>⑤ Commande des aigus (TREBLE)</li> <li>⑥ Interrupteur de tonalité (TONE)</li> <li>⑦ Commande de balance (BALANCE)</li> <li>⑧ Interrupteur d'assourdissement (MUTE)</li> <li>⑨ Interrupteur d'augmentation d'intensité sonore (LOUDNESS)</li> <li>⑩ Interrupteur infra-acoustique (SUBSONIC)</li> <li>⑪ Interrupteur de filtre de haute fréquence (HIGH)</li> <li>⑫ Commutateur de mode (MODE)</li> <li>⑬ Sélecteurs d'entrée (FUNCTION)</li> <li>⑭ Sélecteur phono (PHONO SELECTOR)</li> <li>⑮ Sélecteurs de contrôle de bande magnétique (TAPE MONITOR SELECT)</li> <li>⑯ Sélecteurs de reproduction de bande magnétique (TAPE COPY SELECT)</li> <li>⑰ Interrupteur de reproduction de bande magnétique (TAPE COPY)</li> <li>⑱ Interrupteur de contrôle de bande magnétique (TAPE MONITOR)</li> <li>⑲ Témoin de contrôle de bande magnétique</li> <li>⑳ Témoin de reproduction de bande magnétique</li> </ul> | <ul style="list-style-type: none"> <li>㉑ Témoin d'entrée</li> <li>㉒ Commande de volume (VOLUME)</li> <li>㉓ Témoin à commande directe</li> <li>㉔ Témoin d'enceintes</li> <li>㉕ Borne de mise à la terre (GND)</li> <li>㉖ Prise d'entrée tuner (TUNER INPUT)</li> <li>㉗ Prise d'entrée CD (CD INPUT)</li> <li>㉘ Prise d'entrée phono (PHONO INPUT)</li> <li>㉙ Prise d'entrée AUX-1 (AUX-1 INPUT)</li> <li>㉚ Prise d'entrée AUX-2 (AUX-2 INPUT)</li> <li>㉛ Prise de reproduction de bande 2 (TAPE-2 PLAY)</li> <li>㉜ Prise d'enregistrement de bande 2 (TAPE-2 REC)</li> <li>㉝ Prise de reproduction de bande 1 (TAPE-1 PLAY)</li> <li>㉞ Prise d'enregistrement de bande 1 (TAPE-1 REC)</li> <li>㉟ Bornes d'enceintes (SPEAKER)</li> <li>㊱ Cordon d'alimentation</li> <li>㊲ Prises de sortie CA (4 prises pour appareils vendus aux Etats-Unis et au Canada, 1 prise pour l'Europe, l'Asie et l'Amérique Latine)</li> <li>㊳ Sélecteur de tension (VOLTAGE) (pour l'Allemagne de l'Ouest, l'Asie et l'Amérique Latine)</li> <li>㊴ Pore-fusible (pour l'Allemagne de l'Ouest, l'Asie et l'Amérique Latine)</li> </ul> |
|---|--|



**HITACHI SALES CORPORATION OF AMERICA**  
**Eastern Regional Office**

1200 Wall Street West, Lyndhurst, New Jersey  
07071, U.S.A.  
Tel. 201-935-8980

**Mid-Western Regional Office**

1400 Morse Ave., Elk Grove Village, Ill. 60007, U.S.A.  
Tel. 312-593-1550

**Southern Regional Office**

510 Plaza Drive College Park, Georgia 30349, U.S.A.  
Tel. 404-763-0360

**Western Regional Office**

401 West Artesia Boulevard, Compton, California  
90220, U.S.A.  
Tel. 213-537-8383

**HITACHI SALES CORPORATION OF HAWAII, INC.**

3219 Koapaka Street Honolulu, Hawaii 96819, U.S.A.  
Tel. 808-836-3621

**HITACHI (HSC) CANADA INC.**

3300 Trans Canada Highway, Pointe Claire, Quebec  
H9RU 1 B1, Canada  
Tel. 514-697-9150

**HITACHI SALES EUROPA GmbH**

2050 Hamburg 54, Rungedamm 2, West Germany  
Tel. 73411-0

**HITACHI SALES (U.K.) Ltd.**

Hitachi House, Station Road, Hayes, Middlesex UB3  
4DR, England  
Tel. 01-848-8787 (Service Centre: 01-848-3551)

**HITACHI SALES SCANDINAVIA AB**

Rissneleden 8, Box 7138, 172-07 Sundbyberg,  
Sweden  
Tel. 08-98 52 80

**HITACHI SALES NORWAY A/S**

Oerebekk 1620 Gressvik P.O. Box 46 N-1601  
Fredrikstad, Norway  
Tel. 032-28255

**SUOMEN HITACHI OY**

Takojankatsu 5, 15800 Lahti 80, Finland  
Tel. Lahti 44 241

**HITACHI SALES A/S**

Kuldysen 13, DK-2630 Taastrup, Denmark  
Tel. 02-999200

**HITACHI SALES A.G.**

Bahnhofstrasse, 19, 5600 Lenzburg,  
Switzerland  
Tel. 064-513621

**HITACHI FRANCE S.A.**

97/115 Rue Charles-Michels 93200  
SAINT-DENIS, France  
Tel. 201-25-00

**HITACHI SALES WARENHANDELS GMBH**

A-1180/Wien, Kreuzgasse 27, Austria  
Tel. (0222) 439367/8

**HITACHI SALES BELGIUM S.A./N.V.**

56, Chaussee de Namur, B-1400  
Nivelles, Belgium  
Tel. (067) 22 7181

**HITACHI SALES AUSTRALIA Pty Ltd.**

153 Keys Road, Moorabbin, Victoria 3189, Australia  
Tel. 555-8722

**HITACHI Ltd. TOKYO JAPAN**

Head Office: THE HITACHI ATAGO BLDG.  
No. 15-12, 2-chome Nishi-Shinbashi  
Minato-ku, Tokyo 105, Japan  
Tel. Tokyo (03) 502-2111

**HA-6 TY No. 387 EGF**